

FIRETECH

HİDROLİK & PNÖMATİK FİYAT LİSTESİ

2020

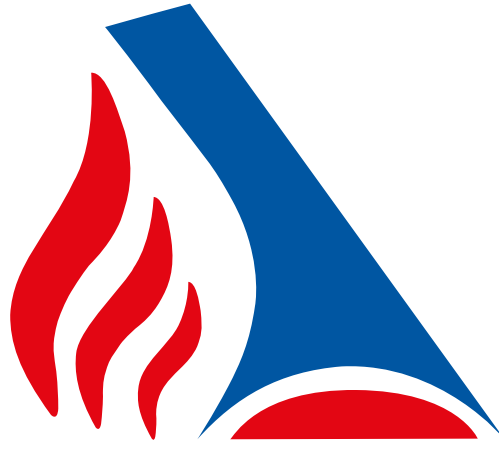

ATEŞ



Değerli iş ortaklarımız;

Ateş AŞ. olarak, sürekli gelişme ilkesi çerçevesinde yeni bir marka ve ürün grubuyla sizlerle tekrar buluşuyoruz; **FIRETECH** Hidrolik ve Pnömatik Malzemeler.

Hidrolik ve Pnömatik Malzemeler alanında **FIRETECH** markamız ile siz değerli iş ortaklarımızın ihtiyaçlarına optimum fiyat&kalite dengesine sahip çözümler üretebilmeyi amaçlıyoruz.

Hedefimiz bu alanda Türkiye'nin en geniş ürün çeşitliliğine, stok miktarına ve yaygınlığına sahip firması olabilmektir. Firmamızın 50 yıllık iş tecrübesini ve bu konudaki kararlılığımızı, profesyonel bir yönetim anlayışı ile birleştirerek hedeflerimize ulaşacağımıza inancımız tamdır.

Saygılarımızla
Ateş AŞ.

www.firetech.com.tr



HIDROOLI

PNEUMAT

Biz Kimiz?

Markalarımız bizim değerlerimizdir. Markalarımız yaşam felsefemizi yansıtır. ATEŞ bir çatı görevi görerek, evinde bir çok değerli markalar yetiştirir, korur ve geliştirir. Her bir markamız, aynı felsefe ve ideoloji ile geliştirilerek desteklenir. Bizim için önemli olan, tüketici sağlığı, ihtiyaçları ve mutluluğudur. İlkelerimizle birlikte kurumsallaşma yolunda güçlü ve sağlam adımlar atarak hareket ederiz. Firma ve markalarımız adına kararlar alırken, geçmişimizin tecrübeleri ve yarınlarımızın hedeflerini göz önüne alarak değerlendiririz.

K

K

FIRETECH



HIDROLI

İçerik:

- **Hirdolik Valfler - Kırmızı Seri** »10-15
- **Hidrolik Valfler - Mavi Seri** »18-31
- **Hidromotorlar** »34-41
- **Soğutucular** »44-45
- **Hat Tipi Komponentler** »48-51



K



The image shows a close-up of a hydraulic valve assembly. The valve is a complex mechanical component with various ports and a handle. A prominent red horizontal bar is overlaid across the middle of the image, containing the text. The background is a warm, orange-red color, suggesting a high-temperature or industrial environment. The lighting is dramatic, highlighting the metallic surfaces of the valve.

Hidrolik Valfler – Kırmızı Seri

Elektrik Uyarılı Yön Denetim Valfleri (Kırmızı Seri)



Stok Kodu	Şema	Açıklama	Fiyat (USD)	
4WE6 D 24VDC		NG6 TEK BOBİN (KRM.ETK.) 4/2 TB – D24	53,3	
4WE6 D 220VAC		NG6 TEK BOBİN (KRM.ETK.) 4/2 TB – A220		
4WE10 D 24VDC		* Kapalı geçişli	NG10 TEK BOBİN (KRM.ETK.) 4/2 TB – D24	90,6
4WE10 D 220VAC			NG10 TEK BOBİN (KRM.ETK.) 4/2 TB – A220	
4WE6 HA 24VDC		NG6 TEK BOBİN (KRM.ETK.) 4/2 HM TB – D24	53,3	
4WE6 HA 220VAC		NG6 TEK BOBİN (KRM.ETK.) 4/2 HM TB – A220		
4WE6 C 24VDC		NG6 TEK BOBİN (KRM.ETK.) 4/2 H GEÇİŞLİ – D24	53,3	
4WE6 C 220VAC		NG6 TEK BOBİN (KRM.ETK.) 4/2 H GEÇİŞLİ – A220		
4WE10 C 24VDC		* H geçişli	NG10 TEK BOBİN (KRM.ETK.) 4/2 H GEÇİŞLİ – D24	90,6
4WE10 C 220VAC			NG10 TEK BOBİN (KRM.ETK.) 4/2 H GEÇİŞLİ – A220	
4WE6 E 24VDC		NG6 ÇİFT BOBİN (KRM.ETK.) 4/3 KM – D24	71,7	
4WE6 E 220VAC		NG6 ÇİFT BOBİN (KRM.ETK.) 4/3 KM – A220		
4WE10 E 24VDC		NG10 ÇİFT BOBİN (KRM.ETK.) 4/3 KM – D24	126,0	
4WE10 E 220VAC				NG10 ÇİFT BOBİN (KRM.ETK.) 4/3 KM – A220
4WE6 H 24VDC		NG6 ÇİFT BOBİN (KRM.ETK.) 4/3 HM – D24	71,7	
4WE6 H 220VAC		NG6 ÇİFT BOBİN (KRM.ETK.) 4/3 HM – A220		
4WE10 H 24VDC		NG10 ÇİFT BOBİN (KRM.ETK.) 4/3 HM – D24	126,0	
4WE10 H 220VAC				NG10 ÇİFT BOBİN (KRM.ETK.) 4/3 HM – A220
4WE6 J 24VDC		NG6 ÇİFT BOBİN (KRM.ETK.) 4/3 ABT – D24	71,7	
4WE6 J 220VAC		NG6 ÇİFT BOBİN (KRM.ETK.) 4/3 ABT – A220		
4WE10 J 24VDC		NG10 ÇİFT BOBİN (KRM.ETK.) 4/3 ABT – D24	126,0	
4WE10 J 220VAC				NG10 ÇİFT BOBİN (KRM.ETK.) 4/3 ABT – A220
4WE6 G 24VDC		NG6 ÇİFT BOBİN (KRM.ETK.) 4/3 AM – D24	71,7	
4WE6 G 220VAC		NG6 ÇİFT BOBİN (KRM.ETK.) 4/3 AM – A220		
4WE10 G 24VDC		NG10 ÇİFT BOBİN (KRM.ETK.) 4/3 AM – D24	127,0	
4WE10 G 220VAC				NG10 ÇİFT BOBİN (KRM.ETK.) 4/3 AM – A220

Max Çalışma Basıncı : 315 bar
 Max Debi : 60 lt/dak(NG6), 120 lt/dak(NG10)
 Çalışma Sıcaklığı : -30 ~ 80 °C

Fiyatlarımız USD cinsindedir.

Modüler Kilit ve Debi Ayar Valfleri



Stok Kodu	Şema	Açıklama	Fiyat (USD)
Z2S-6		KİLİT VALF NG6 AB HATTI (KRM.ETK.)	41
Z2S-10		KİLİT VALF NG10 AB HATTI (KRM.ETK.)	65,9
Z2FS-6		DEBİ AYAR VALF NG6 AB HATTI (KRM.ETK.)	41
Z2FS-10		DEBİ AYAR VALF NG10 AB HATTI (KRM.ETK.)	65

Max Çalışma Basıncı : 315 bar

NG16 Yön Denetim Valfleri

Stok Kodu	Şema	Açıklama	Fiyat (USD)
4WEH16 D 6X/ET		NG16 GÖVDE 4/2 (KRM.ETK.) - TB	166
4WEH16 E 6X/ET		NG16 GÖVDE 4/3 (KRM.ETK.) - KM	166
4WEH16 H 6X/ET		NG16 GÖVDE 4/3 (KRM.ETK.) - HM	166
4WEH16 J 6X/ET		NG16 GÖVDE 4/3 (KRM.ETK.) - ABT	166
4WEH16 G 6X/ET		NG16 GÖVDE 4/3 (KRM.ETK.) - AM	178

* Pilot valfi fiyata dahil değildir, haricen sipariş verilmelidir

** Valfler; dahili pilot ve dahili sızıntılıdır

Mekanik Uyarılı (Kollu) Yön Denetim Valfleri (Kırmızı Seri)



Stok Kodu	Şema	Açıklama	Fiyat (USD)
4WMM6 D 80		NG6 KOLLU VALF (KRM.ETK.) 4/2 TB	75,9
4WMM6 E 80		NG6 KOLLU VALF (KRM.ETK.) 4/3 KM	75,9
4WMM6 H 80		NG6 KOLLU VALF (KRM.ETK.) 4/3 HM	75,9
4WMM6 J 80		NG6 KOLLU VALF (KRM.ETK.) 4/3 ABT	75,9
4WMM6 G 80		NG6 KOLLU VALF (KRM.ETK.) 4/3 AM	78,8
4WMM6 D 80 F		NG6 KOLLU VALF (KRM.ETK.) 4/2 TB - DETANTLI	75,9
4WMM6 E 80 F		NG6 KOLLU VALF (KRM.ETK.) 4/3 KM - DETANTLI	75,9
4WMM6 H 80 F		NG6 KOLLU VALF (KRM.ETK.) 4/3 HM - DETANTLI	75,9
4WMM6 J 80 F		NG6 KOLLU VALF (KRM.ETK.) 4/3 ABT - DETANTLI	75,9
4WMM6 G 80 F		NG6 KOLLU VALF (KRM.ETK.) 4/3 AM - DETANTLI	78,8

Max Çalışma Basıncı : 315 bar
 Max Debi : 60 lt/dak(NG6)
 Çalışma Sıcaklığı : -30 ~ 80 °C

Hassas Hız Ayar Valfi (Kırmızı Seri)



Stok Kodu	Şema	Açıklama	Fiyat (USD)
2FRM 5		HASSAS HIZ AYAR VALFİ, 0.2 lt/dak	209
2FRM 6		HASSAS HIZ AYAR VALFİ, 6 lt/dak	218

Max Çalışma Basıncı : 315 bar

Oransal Valf Kartları



Stok Kodu	Açıklama	Fiyat (USD)
ADF11-A-D2-3-40	ORANSAL VALF KARTI 0-10VDC (SOKET TİPİ)	204
ADE-11-A-01-D2-3-40	ORANSAL V.KARTI, TEK ÇIKIŞ 0-10VDC (PANO TİPİ)	204
ADE-11-A-02-D2-3-40	ORANSAL V.KARTI, ÇİFT ÇIKIŞ 0-10VDC (PANO TİPİ)	318

Valf Aksesuarları

Stok Kodu	Açıklama	Fiyat (USD)
Z8-60 YC 12V	NG6 BOBİN 12VDC (KRM.ETK.)	17,8
Z8-60 YC 24V	NG6 BOBİN 24VDC (KRM.ETK.)	17,8
B8-60 YC 110V	NG6 BOBİN 110VAC (KRM.ETK.)	17,8
B8-60 YC 220V	NG6 BOBİN 220VAC (KRM.ETK.)	17,8
Z8-120 YC 12V	NG10 BOBİN 12VDC (KRM.ETK.)	32,5
Z8-120 YC 24V	NG10 BOBİN 24VDC (KRM.ETK.)	32,5
B8-120 YC 110V	NG10 BOBİN 110VAC (KRM.ETK.)	32,5
B8-120 YC 220V	NG10 BOBİN 220VAC (KRM.ETK.)	32,5
CONNECTOR-DC	İŞIKLI SOKET DC	5,75
CONNECTOR-AC	İŞIKLI SOKET AC	5,75







Hidrolik Valfler – Mavi Seri

NG6 Tek Bobin Elektrik Uyarılı Yön Denetim Valfleri



Stok Kodu	Şema	Açıklama	Fiyat (USD)
SWH-G02-B2-A110-20		NG6 TEK BOBİN 4/2 TB - A110	82,5
SWH-G02-B2-A220-20		NG6 TEK BOBİN 4/2 TB - A220	82,5
SWH-G02-B2-D12-20		NG6 TEK BOBİN 4/2 TB - D12	82,5
SWH-G02-B2-D24-20		* Kapalı Geçişli	NG6 TEK BOBİN 4/2 TB - D24
SWH-G02-B3-A110-20		NG6 TEK BOBİN 4/2 HA - A110	82,5
SWH-G02-B3-A220-20		NG6 TEK BOBİN 4/2 HA - A220	82,5
SWH-G02-B3-D12-20		NG6 TEK BOBİN 4/2 HA - D12	82,5
SWH-G02-B3-D24-20		* H Geçişli	NG6 TEK BOBİN 4/2 HA - D24
SWH-G02-C2BS-A110-20		NG6 TEK BOBİN 4/2 TB KM - A110	82,5
SWH-G02-C2BS-A220-20		NG6 TEK BOBİN 4/2 TB KM - A220	82,5
SWH-G02-C2BS-D12-20		NG6 TEK BOBİN 4/2 TB KM - D12	82,5
SWH-G02-C2BS-D24-20		NG6 TEK BOBİN 4/2 TB KM - D24	82,5
SWH-G02-C3BS-A110-20		NG6 TEK BOBİN 4/2 TB HM - A110	82,5
SWH-G02-C3BS-A220-20		NG6 TEK BOBİN 4/2 TB HM - A220	82,5
SWH-G02-C3BS-D12-20		NG6 TEK BOBİN 4/2 TB HM - D12	82,5
SWH-G02-C3BS-D24-20		NG6 TEK BOBİN 4/2 TB HM - D24	82,5
SWH-G02-C3B-D12-20		NG6 TEK BOBİN 4/2 HM TB – D12	82,5
SWH-G02-C3B-D24-20		NG6 TEK BOBİN 4/2 HM TB – D24	82,5
SWH-G02-C3B-A110-20		NG6 TEK BOBİN 4/2 HM TB – A110	82,5
SWH-G02-C3B-A220-20		NG6 TEK BOBİN 4/2 HM TB – A220	82,5
SWH-G02-C8SB-D24-20		NG6 TEK BOBİN 4/2 TB BT – D24	82,5
SWH-G02-C8SB-A220-20		NG6 TEK BOBİN 4/2 TB BT – A220	82,5
SWH-G02-C7B-D24-20		NG6 TEK BOBİN 4/2 TB ABP – D24	82,5
SWH-G02-C7B-A220-20		NG6 TEK BOBİN 4/2 TB ABP – A220	82,5
SWH-G02-C5B-D24-20		NG6 TEK BOBİN 4/2 TB PTA – D24	82,5
SWH-G02-C5B-A220-20		NG6 TEK BOBİN 4/2 TB PTA – A220	82,5

Max Çalışma Basıncı : 315 bar
 Max Debi : 63 lt/dak
 Çalışma Sıcaklığı : -25 ~ 90 °C

NG6 Çift Bobin Elektrik Uyarılı Yön Denetim Valfleri



Stok Kodu	Şema	Açıklama	Fiyat (USD)
SWH-G02-C2-A110-20		NG6 ÇİFT BOBİN 4/3 KM - A110	114
SWH-G02-C2-A220-20		NG6 ÇİFT BOBİN 4/3 KM - A220	114
SWH-G02-C2-D12-20		NG6 ÇİFT BOBİN 4/3 KM - D12	114
SWH-G02-C2-D24-20		NG6 ÇİFT BOBİN 4/3 KM - D24	114
SWH-G02-C3-A110-20		NG6 ÇİFT BOBİN 4/3 HM - A110	114
SWH-G02-C3-A220-20		NG6 ÇİFT BOBİN 4/3 HM - A220	114
SWH-G02-C3-D12-20		NG6 ÇİFT BOBİN 4/3 HM - D12	114
SWH-G02-C3-D24-20		NG6 ÇİFT BOBİN 4/3 HM - D24	114
SWH-G02-C4-A110-20		NG6 ÇİFT BOBİN 4/3 ABT - A110	114
SWH-G02-C4-A220-20		NG6 ÇİFT BOBİN 4/3 ABT - A220	114
SWH-G02-C4-D12-20		NG6 ÇİFT BOBİN 4/3 ABT - D12	114
SWH-G02-C4-D24-20		NG6 ÇİFT BOBİN 4/3 ABT - D24	114
SWH-G02-C6-A110-20		NG6 ÇİFT BOBİN 4/3 AM - A110	114
SWH-G02-C6-A220-20		NG6 ÇİFT BOBİN 4/3 AM - A220	114
SWH-G02-C6-D12-20		NG6 ÇİFT BOBİN 4/3 AM - D12	114
SWH-G02-C6-D24-20		NG6 ÇİFT BOBİN 4/3 AM - D24	114
SWH-G02-C8S-D24-20		NG6 ÇİFT BOBİN 4/3 BT – D24	114
SWH-G02-C8S-A220-20		NG6 ÇİFT BOBİN 4/3 BT – A220	114
SWH-G02-C7-D24-20		NG6 ÇİFT BOBİN 4/3 ABP – D24	114
SWH-G02-C7-A220-20		NG6 ÇİFT BOBİN 4/3 ABP – A220	114
SWH-G02-C5-D24-20		NG6 ÇİFT BOBİN 4/3 PTA – D24	114
SWH-G02-C5-A220-20		NG6 ÇİFT BOBİN 4/3 PTA -A220	114
SWH-G02-D2-D12-20		NG6 ÇİFT BOBİN 4/2 TB DETANTLI - D12	114
SWH-G02-D2-D24-20		NG6 ÇİFT BOBİN 4/2 TB DETANTLI - D24	114

Max Çalışma Basıncı : 315 bar
 Max Debi : 63 lt/dak
 Çalışma Sıcaklığı : -25 ~ 90 °C

NG10 Tek Bobin Elektrik Uyarılı Yön Denetim Valfleri



Stok Kodu	Şema	Açıklama	Fiyat (USD)
SWH-G03-B2-A110-20		NG10 TEK BOBİN 4/2 TB - A110	132
SWH-G03-B2-A220-20		NG10 TEK BOBİN 4/2 TB - A220	132
SWH-G03-B2-D12-20		NG10 TEK BOBİN 4/2 TB - D12	132
SWH-G03-B2-D24-20		* Kapalı Geçişli	NG10 TEK BOBİN 4/2 TB - D24
SWH-G03-B3-A110-20		NG10 TEK BOBİN 4/2 HA - A110	132
SWH-G03-B3-A220-20		NG10 TEK BOBİN 4/2 HA - A220	132
SWH-G03-B3-D12-20		NG10 TEK BOBİN 4/2 HA - D12	132
SWH-G03-B3-D24-20		* H Geçişli	NG10 TEK BOBİN 4/2 HA - D24
SWH-G03-C2BS-A110-20		NG10 TEK BOBİN 4/2 TB KM - A110	132
SWH-G03-C2BS-A220-20		NG10 TEK BOBİN 4/2 TB KM - A220	132
SWH-G03-C2BS-D12-20		NG10 TEK BOBİN 4/2 TB KM - D12	132
SWH-G03-C2BS-D24-20		NG10 TEK BOBİN 4/2 TB KM - D24	132
SWH-G03-C3BS-A110-20		NG10 TEK BOBİN 4/2 TB HM - A110	132
SWH-G03-C3BS-A220-20		NG10 TEK BOBİN 4/2 TB HM - A220	132
SWH-G03-C3BS-D12-20		NG10 TEK BOBİN 4/2 TB HM - D12	132
SWH-G03-C3BS-D24-20		NG10 TEK BOBİN 4/2 TB HM - D24	132
SWH-G03-C3B-D12-20		NG10 TEK BOBİN 4/2 HM TB - D12	132
SWH-G03-C3B-D24-20		NG10 TEK BOBİN 4/2 HM TB - D24	132
SWH-G03-C3B-A110-20		NG10 TEK BOBİN 4/2 HM TB - A110	132
SWH-G03-C3B-A220-20		NG10 TEK BOBİN 4/2 HM TB - A220	132
SWH-G03-C8SB-D24-20		NG10 TEK BOBİN 4/2 TB BT - D24	132
SWH-G03-C8SB-A220-20		NG10 TEK BOBİN 4/2 TB BT - A220	132
SWH-G03-C7B-D24-20		NG10 TEK BOBİN 4/2 TB ABP - D24	132
SWH-G03-C7B-A220-20		NG10 TEK BOBİN 4/2 TB ABP - A220	132
SWH-G03-C5B-D24-20		NG10 TEK BOBİN 4/2 TB PTA - D24	132
SWH-G03-C5B-A220-20		NG10 TEK BOBİN 4/2 TB PTA - A220	132

Max Çalışma Basıncı : 315 bar
 Max Debi : 120 lt/dak
 Çalışma Sıcaklığı : -25 ~ 90 °C

Fiyatlarımız USD cinsindedir.

NG10 Çift Bobin Elektrik Uyarılı Yön Denetim Valfleri



Stok Kodu	Şema	Açıklama	Fiyat (USD)
SWH-G03-C2-A110-20		NG10 ÇİFT BOBİN 4/3 KM - A110	170
SWH-G03-C2-A220-20		NG10 ÇİFT BOBİN 4/3 KM - A220	170
SWH-G03-C2-D12-20		NG10 ÇİFT BOBİN 4/3 KM - D12	170
SWH-G03-C2-D24-20		NG10 ÇİFT BOBİN 4/3 KM - D24	170
SWH-G03-C3-A110-20		NG10 ÇİFT BOBİN 4/3 HM - A110	170
SWH-G03-C3-A220-20		NG10 ÇİFT BOBİN 4/3 HM - A220	170
SWH-G03-C3-D12-20		NG10 ÇİFT BOBİN 4/3 HM - D12	170
SWH-G03-C3-D24-20		NG10 ÇİFT BOBİN 4/3 HM - D24	170
SWH-G03-C4-A110-20		NG10 ÇİFT BOBİN 4/3 ABT - A110	170
SWH-G03-C4-A220-20		NG10 ÇİFT BOBİN 4/3 ABT - A220	170
SWH-G03-C4-D12-20		NG10 ÇİFT BOBİN 4/3 ABT - D12	170
SWH-G03-C4-D24-20		NG10 ÇİFT BOBİN 4/3 ABT - D24	170
SWH-G03-C6-A110-20		NG10 ÇİFT BOBİN 4/3 AM - A110	170
SWH-G03-C6-A220-20		NG10 ÇİFT BOBİN 4/3 AM - A220	170
SWH-G03-C6-D12-20		NG10 ÇİFT BOBİN 4/3 AM - D12	170
SWH-G03-C6-D24-20		NG10 ÇİFT BOBİN 4/3 AM - D24	170
SWH-G03-C8S-D24-20		NG10 ÇİFT BOBİN 4/3 BT – D24	170
SWH-G03-C8S-A220-20		NG10 ÇİFT BOBİN 4/3 BT – A220	170
SWH-G03-C7-D24-20		NG10 ÇİFT BOBİN 4/3 ABP – D24	170
SWH-G03-C7-A220-20		NG10 ÇİFT BOBİN 4/3 ABP – A220	170
SWH-G03-C5-D24-20		NG10 ÇİFT BOBİN 4/3 PTA – D24	170
SWH-G03-C5-A220-20		NG10 ÇİFT BOBİN 4/3 PTA -A220	170

Max Çalışma Basıncı : 315 bar
 Max Debi : 120 lt/dak
 Çalışma Sıcaklığı : -25 ~ 90 °C

Fiyatlarımız USD cinsindedir.

NG16/25/32 Elektrik Uyarılı Yön Denetim Valfleri

HPD-G04-C



HPD-G10-C



HPD-G06-C



Stok Kodu	Şema	Açıklama	Fiyat (USD)
HPD-G04-B2-ET		NG16 4/2 GÖVDE	152
HPD-G06-B2-ET		NG25 4/2 GÖVDE	235
HPD-G10-B2-ET		NG32 4/2 GÖVDE	1.375
HPD-G04-C2-ET		NG16 4/3 GÖVDE - KAPALI MERKEZ	152
HPD-G06-C2-ET		NG25 4/3 GÖVDE - KAPALI MERKEZ	235
HPD-G10-C2-ET		NG32 4/3 GÖVDE - KAPALI MERKEZ	1.375
HPD-G04-C3-ET		NG16 4/3 GÖVDE - H MERKEZ	152
HPD-G06-C3-ET		NG25 4/3 GÖVDE - H MERKEZ	235
HPD-G10-C3-ET		NG32 4/3 GÖVDE - H MERKEZ	1.375
HPD-G04-C4-ET		NG16 4/3 GÖVDE - ABT	152
HPD-G06-C4-ET		NG25 4/3 GÖVDE - ABT	235
HPD-G10-C4-ET		NG32 4/3 GÖVDE - ABT	1.375
HPD-G04-C6-ET		NG16 4/3 GÖVDE - AÇIK MERKEZ	152
HPD-G06-C6-ET		NG25 4/3 GÖVDE - AÇIK MERKEZ	235
HPD-G10-C6-ET		NG32 4/3 GÖVDE - AÇIK MERKEZ	1.375

* Pilot valfi fiyata dahil değildir, haricen sipariş verilmelidir

** Valfler; harici pilot ve harici sızıntılıdır

Modüler Basınç Emniyet Valfleri

MRF-02B-3-40-K



MRF-03P-3-40-K

Stok Kodu	Şema	Açıklama	Fiyat (USD)
MRF-02P-3-40-K(B)	MRF-P 	BASINÇ AYAR VALFİ NG6 P HATTI, 70~210 bar	77
MRF-02A-3-40-K(B)	MRF-A 	BASINÇ AYAR VALFİ NG6 A HATTI, 70~210 bar	77
MRF-02B-3-40-K(B)	MRF-B 	BASINÇ AYAR VALFİ NG6 B HATTI, 70~210 bar	77
MRF-02C-3-40-K	MRF-C 	BASINÇ AYAR VALFİ NG6 AB HATTI, 70~210 bar	142
MRF-03P-3-30-K(B)	MRF-B 	BASINÇ AYAR VALFİ NG10 P HATTI, 70~210 bar	95
MRF-03A-3-30-K(B)	MRF-A 	BASINÇ AYAR VALFİ NG10 A HATTI, 70~210 bar	95
MRF-03B-3-30-K(B)	MRF-C 	BASINÇ AYAR VALFİ NG10 B HATTI, 70~210 bar	95
MRF-03C-3-30-K	MRF-C 	BASINÇ AYAR VALFİ NG10 AB HATTI, 70~210 bar	217

Modüler Pilot Uyarılı Çekvalf (Kilit Valfi)

MPC-02W-40



MPC-03W-40



MPC-04W-40



MPC-06W-40





Stok Kodu	Şema	Açıklama	Fiyat (USD)
MPC-02A-40	<p>MPC-A</p>	KİLİT VALF NG6 A HATTI	63
MPC-02B-40		KİLİT VALF NG6 B HATTI	63
MPC-02W-40		KİLİT VALF NG6 AB HATTI	77
MPC-03A-40	<p>MPC-B</p>	KİLİT VALF NG10 A HATTI	87
MPC-03B-40		KİLİT VALF NG10 B HATTI	87
MPC-03W-40		KİLİT VALF NG10 AB HATTI	99
MPC-04W-40	<p>MPC-W</p>	KİLİT VALF NG16 AB HATTI	488
MPC-06W-40		KİLİT VALF NG25 AB HATTI	510

Modüler Basınç Düşürücü Valfler

MPR-02P-3-30-K



MPR-03P-3-30-K

Stok Kodu	Şema	Açıklama	Fiyat (USD)
MPR-02A-3-30-K(B)	 MPR-P	BASINC DUSURUCU VALF NG6 A HATTI, 70~210 bar	74
MPR-02B-3-30-K(B)		BASINC DUSURUCU VALF NG6 B HATTI, 70~210 bar	74
MPR-02P-3-30-K(B)	 MPR-A	BASINC DUSURUCU VALF NG6 P HATTI, 70~210 bar	74
MPR-03A-3-30-K(B)		BASINC DUSURUCU VALF NG10 A HATTI, 70~210 bar	95
MPR-03B-3-30-K(B)	 MPR-B	BASINC DUSURUCU VALF NG10 B HATTI, 70~210 bar	95
MPR-03P-3-30-K(B)		BASINC DUSURUCU VALF NG10 P HATTI, 70~210 bar	95

Modüler Basınç Sıralama Valfleri



Stok Kodu	Şema	Açıklama	Fiyat (USD)
MSCV-02A-2-K	<p>MSCV-02A</p>	BASINÇ SIRALAMA VALFİ NG6 A HATTI, 7~210 bar	134
MSCV-02B-2-K	<p>MSCV-02B</p>	BASINÇ SIRALAMA VALFİ NG6 B HATTI, 7~210 bar	134
MSV-02P-2-K	<p>MSV</p>	BASINÇ SIRALAMA VALFİ NG6 P HATTI, 7~210 bar	134

Modüler Basınç Şalteri NG6

MPS-02W-230-20-K



Stok Kodu	Şema	Açıklama	Fiyat (USD)
MPS-02P-150-20-K-B		MODULER BASINÇ ŞALTERİ P HATTI 30~150 bar	130
MPS-02P-230-20-K-B		MODULER BASINÇ ŞALTERİ P HATTI 50~230 bar	130
MPS-02A-150-20-K-A		MODULER BASINÇ ŞALTERİ A HATTI 30~150 bar	130
MPS-02A-230-20-K-A		MODULER BASINÇ ŞALTERİ A HATTI 50~230 bar	130
MPS-02B-150-20-K-A		MODULER BASINÇ ŞALTERİ B HATTI 30~150 bar	130
MPS-02B-230-20-K-A		MODULER BASINÇ ŞALTERİ B HATTI 50~230 bar	130
MPS-02W-150-20-K		MODULER BASINÇ ŞALTERİ AB HATTI 30~150 bar	273
MPS-02W-230-20-K		MODULER BASINÇ ŞALTERİ AB HATTI 50~230 bar	306

Modüler Hız Ayar Valfleri

MT-02W-30-K



MT-03W-30-K



Stok Kodu	Şema	Açıklama	Fiyat (USD)
MT-02A-30-K		DEBİ AYAR VALF NG6 A HATTI	63
MT-03A-30-K		DEBİ AYAR VALF NG10 A HATTI	87
MT-02B-30-K		DEBİ AYAR VALF NG6 B HATTI	63
MT-03B-30-K		DEBİ AYAR VALF NG10 B HATTI	87
MT-02W-30-K		DEBİ AYAR VALF NG6 AB HATTI	71
MT-03W-30-K		DEBİ AYAR VALF NG10 AB HATTI	104

Pleyt Tipi Emniyet Valfleri

HRF-G03-3-R-30



HSRF-G06-1PN-3-R-A220-20

Stok Kodu	Şema	Açıklama	Fiyat (USD)
HRF-G03-3-R-30		BASINÇ AYAR NG10 MANUEL	228
HRF-G06-3-R-30		BASINÇ AYAR NG25 MANUEL	252
HSRF-G03-1PN-3-R-30 W/O		SIFIRLAMALI TİP BASINÇ AYAR NG10 - GÖVDE*	242
HSRF-G03-1PN-3-R-A220-20		SIFIRLAMALI TİP BASINÇ AYAR NG10 - 220AC *	306
HSRF-G06-1PN-3-R-30 W/O		SIFIRLAMALI TİP BASINÇ AYAR NG25 - GÖVDE*	259
HSRF-G06-1PN-3-R-A220-20		SIFIRLAMALI TİP BASINÇ AYAR NG25 - 220AC**	339

Not: Ayar basınç aralığı 7 ~ 210 bar'dır

* Pilot valf hariçtir

** Pilot valfi fiyata dahil olup montajlı olarak teslim edilir.

Oransal Basınç ve Debi Kontrol Valfleri

ER-G01-3-10



ER-G06-3-10



EFBG-03-125-H



Stok Kodu	Şema	Açıklama	Fiyat (USD)
ER-G01-3-10		ORANSAL PİLOT BASINÇ SINIRLAMA VALFİ NG6	356
ER-G03-3-10		ORANSAL BASINÇ SINIRLAMA VALFİ NG10	621
ER-G06-3-10		ORANSAL BASINÇ SINIRLAMA VALFİ NG25	649
ER-G10-3-10		ORANSAL BASINÇ SINIRLAMA VALFİ NG32	959
EFBG-10-500-H			ORANSAL P-Q VALFİ NG32 (40 Ohm-10 Ohm)

Basınç Şalterleri



DNL-100K-21B

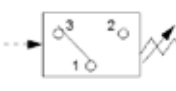

Stok Kodu	Şema	Açıklama	Fiyat (USD)
PS-150-20		1/4" HAT TIPI BASINÇ ŞALTERİ 30~150 bar	130
PS-230-20		1/4" HAT TIPI BASINÇ ŞALTERİ 50~230 bar	130
PS-420-20		1/4" HAT TIPI BASINÇ ŞALTERİ 90~420 bar	130
DNL-100K-21B		BASINÇ ŞALTERİ - DNL 100K 15~100 bar	211
DNL-280K-21B		BASINÇ ŞALTERİ - DNL 280K 40~280 bar	211
DNL-400K-21B		BASINÇ ŞALTERİ - DNL 400K 50~400 bar	211

Valf Aksesuarları

Stok Kodu	Açıklama	Fiyat (USD)
COIL-G02-D12-20	BOBIN NG6 12 VOLT DC	25,9
COIL-G02-D24-20	BOBIN NG6 24 VOLT DC	25,9
COIL-G02-A110-20	BOBIN NG6 110 VOLT AC	25,9
COIL-G02-A220-20	BOBIN NG6 220 VOLT AC	25,9
COIL-G03-D12-20	BOBIN NG10 12 VOLT DC	53,8
COIL-G03-D24-20	BOBIN NG10 24 VOLT DC	53,8
COIL-G03-A110-20	BOBIN NG10 110 VOLT AC	53,8
COIL-G03-A220-20	BOBIN NG10 220 VOLT AC	53,8



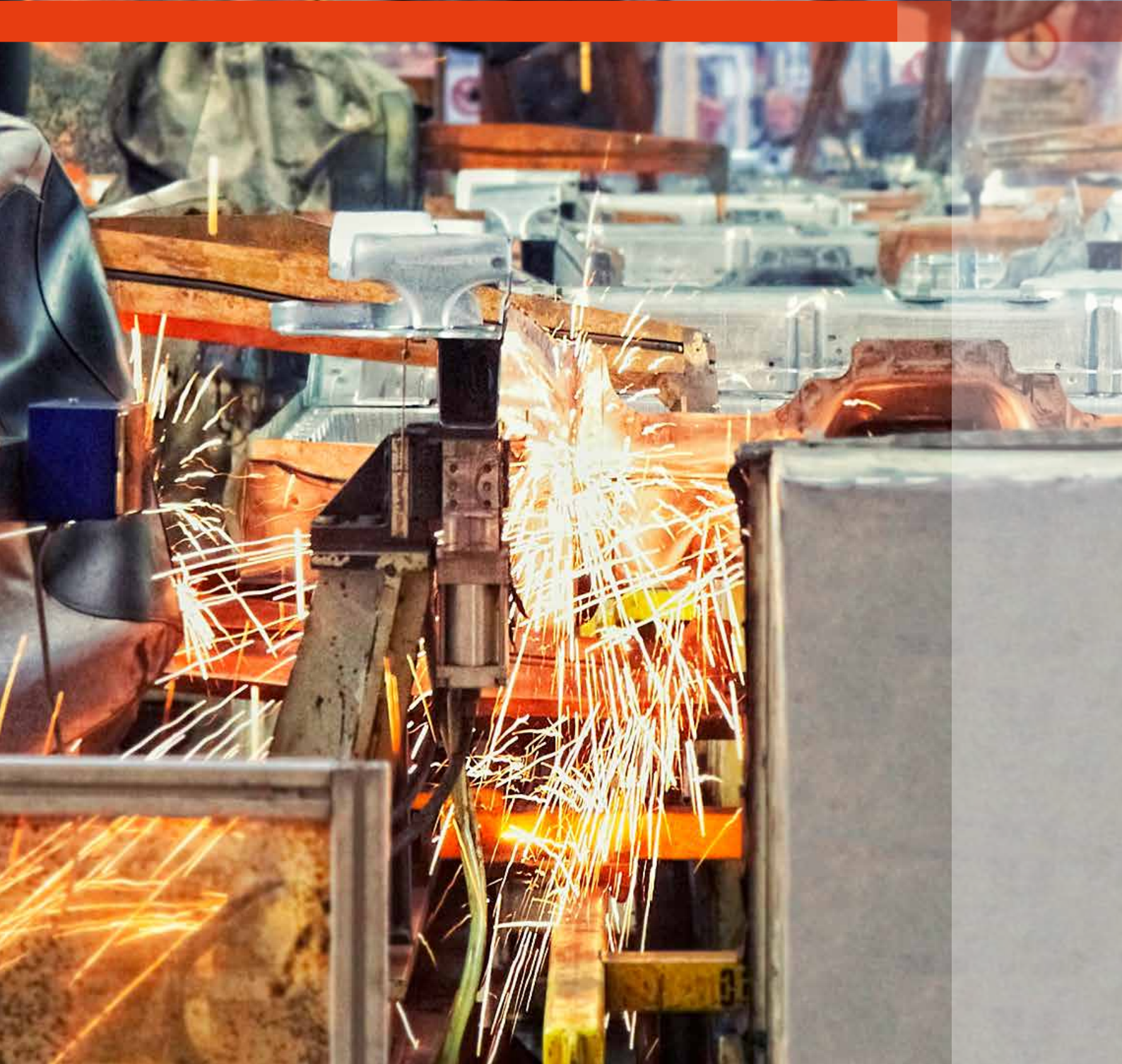

Hidromotorlar

Hidromotor / BMM Model Ölçü ve Montaj Bilgisi



Model	Mil Çapı mm	Motor Depl. (cc/rev)	Dönüş Hızı (rpm)	Δp (bar)	Tork (Nm)	Debi (lt/dak)	Fiyat (USD)
BMM8	Ø16	8,2	1950	100	11	16	168
BMM12.5	Ø16	12,9	1550	100	16	20	168
BMM20	Ø16	19,9	1000	100	25	20	170
BMM32	Ø16	31,6	630	100	40	20	173
BMM40	Ø16	39,8	500	90	45	20	177
BMM50	Ø16	50,3	400	70	46	20	181

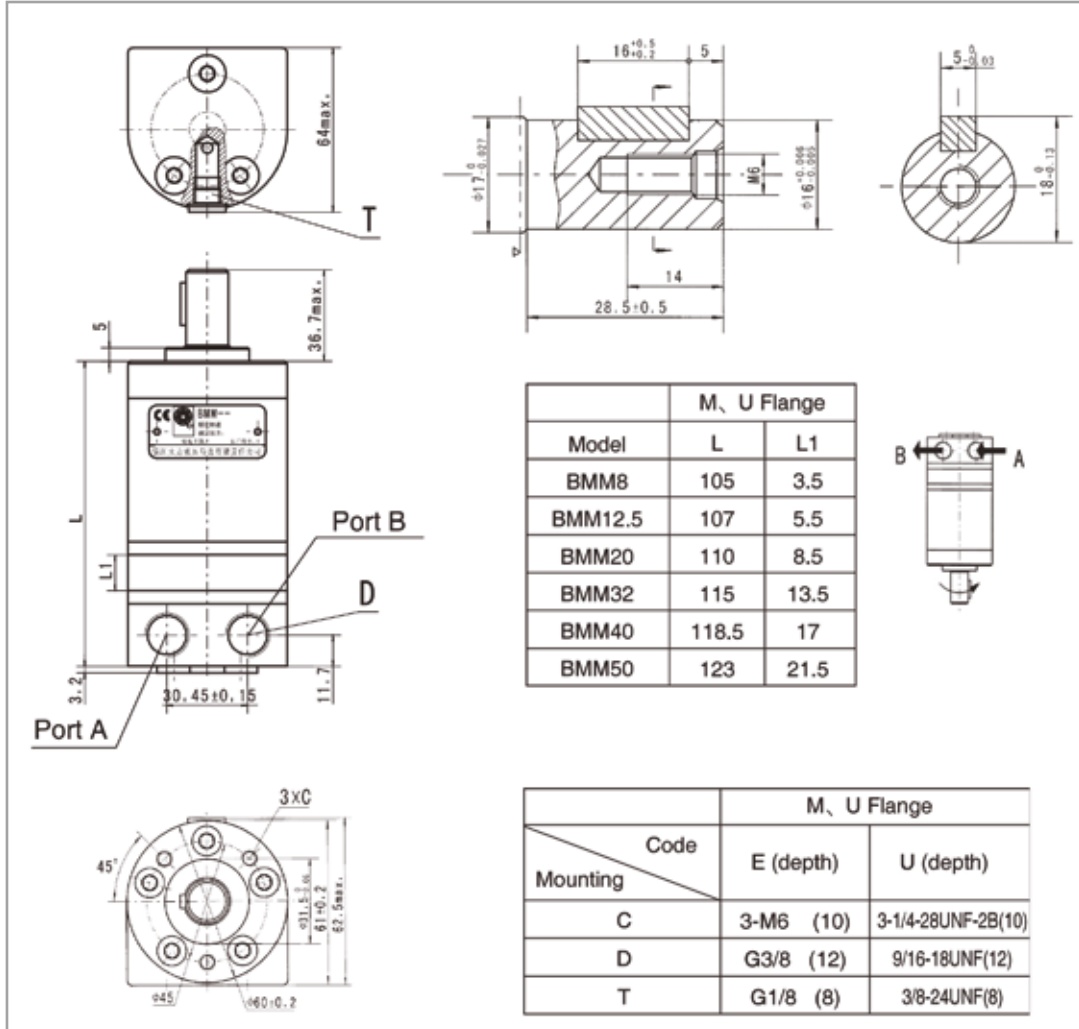

Hidromotor / BMP Model Ölçü ve Montaj Bilgisi



Model	Mil Çapı mm	Motor Depl. (cc/rev)	Dönüş Hızı (rpm)	Δp (bar)	Tork (Nm)	Debi (lt/dak)	Fiyat (USD)
BMP36	Ø25	36	1500	125	55	55	165
BMP50	Ø25	51,7	1150	140	100	60	165
BMP80	Ø25	77,7	770	140	146	60	169
BMP100	Ø25	96,2	615	140	182	60	172
BMP125	Ø25	120,2	490	140	236	60	176
BMP160	Ø25	157,2	383	140	302	60	180
BMP200	Ø25	194,5	310	140	360	60	187
BMP250	Ø25	240,3	250	110	380	60	191
BMP315	Ø25	314,5	192	90	375	60	198
BMP400	Ø25	389,5	155	70	360	60	205

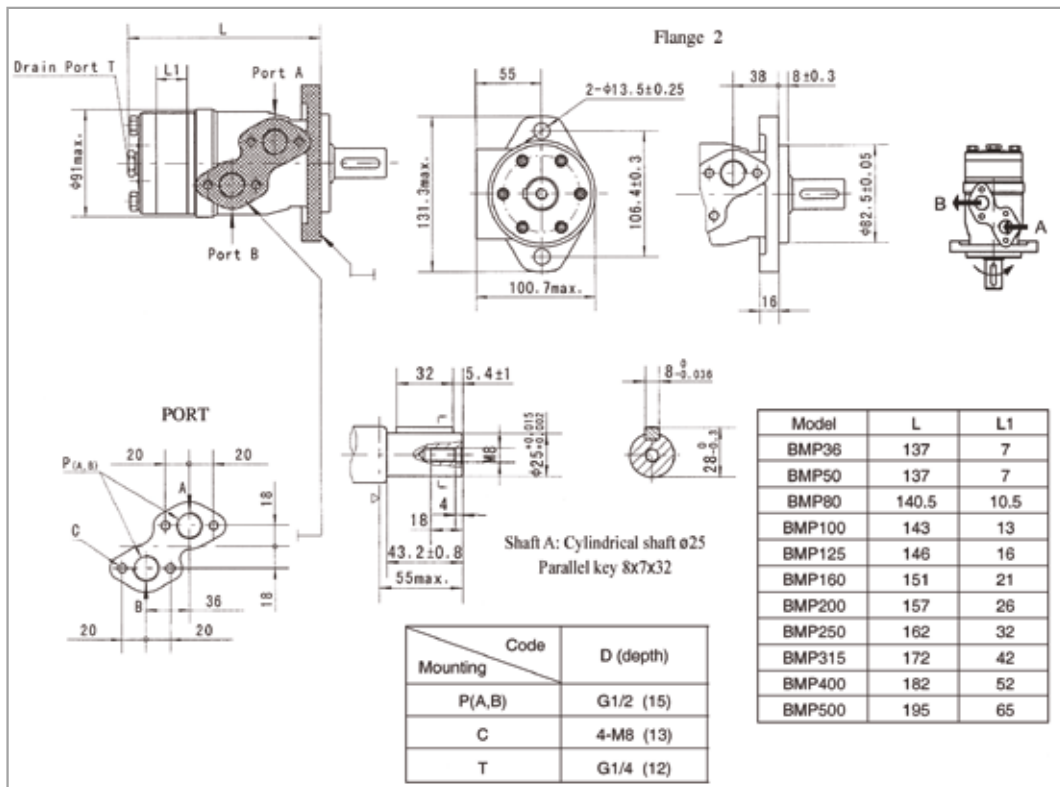

Hidromotor / BMR Model Ölçü ve Montaj Bilgisi



Model	Mil Çapı mm	Motor Depl. (cc/rev)	Dönüş Hızı (rpm)	Δp (bar)	Tork (Nm)	Debi (lt/dak)	Fiyat (USD)
BMR36	Ø25	36	1085	140	72	40	183
BMR50	Ø25	51,7	960	140	100	50	183
BMR80	Ø25	81,5	750	175	195	60	187
BMR100	Ø25	102	600	175	240	60	191
BMR125	Ø25	127,2	475	175	300	60	194
BMR160	Ø25	157,2	378	165	360	60	198
BMR200	Ø25	194,5	310	130	360	60	205
BMR250	Ø25	253,3	240	110	390	60	209
BMR315	Ø25	317,5	190	90	390	60	216
BMR375	Ø25	381,4	155	70	365	60	224

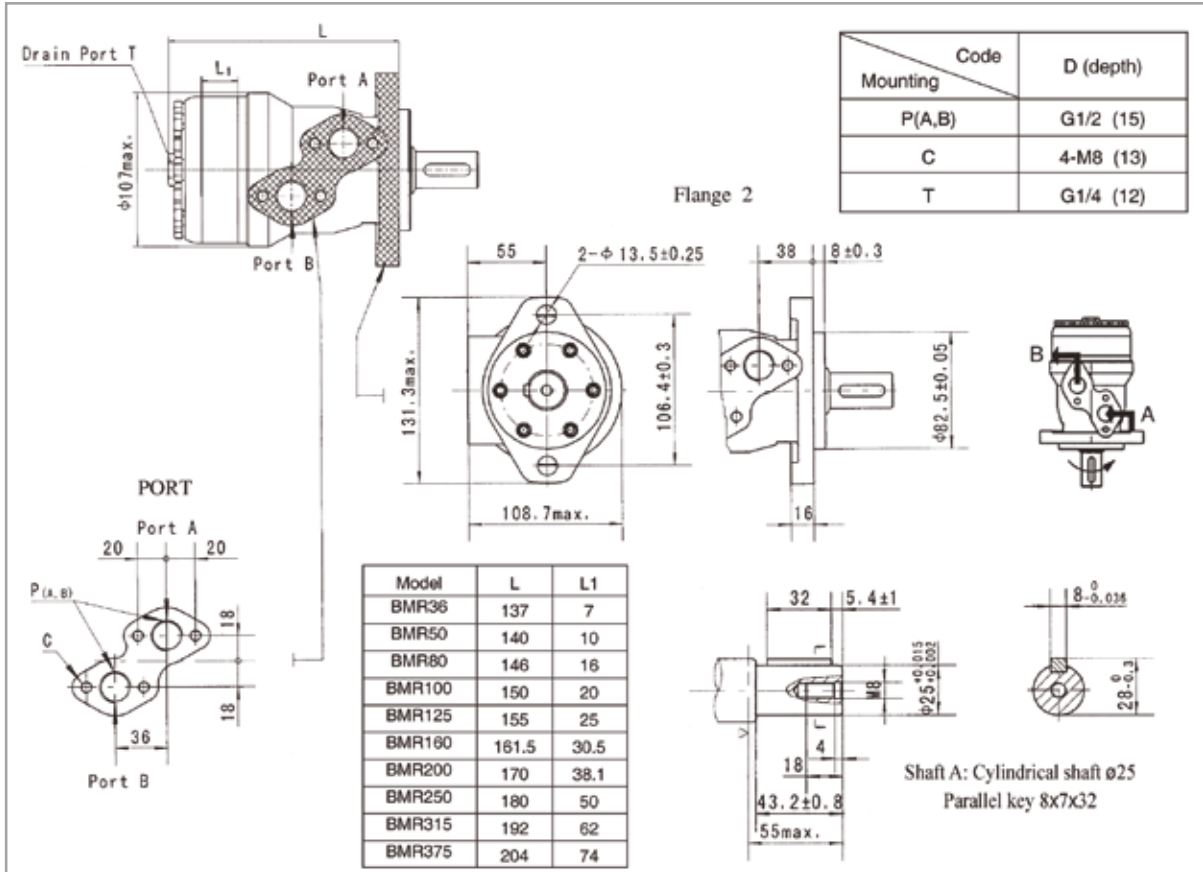

Hidromotor / BMH Model Ölçü ve Montaj Bilgisi



Model	Mil Çapı mm	Motor Depl. (cc/rev)	Dönüş Hızı (rpm)	Δp (bar)	Tork (Nm)	Debi (lt/dak)	Fiyat (USD)
BMH400	Ø32	406,4	183	155	850	75	304
BMH500		489,2	155	125	830	75	311
BMH400	Ø35	406,4	183	155	850	75	304
BMH500		489,2	155	125	830	75	311

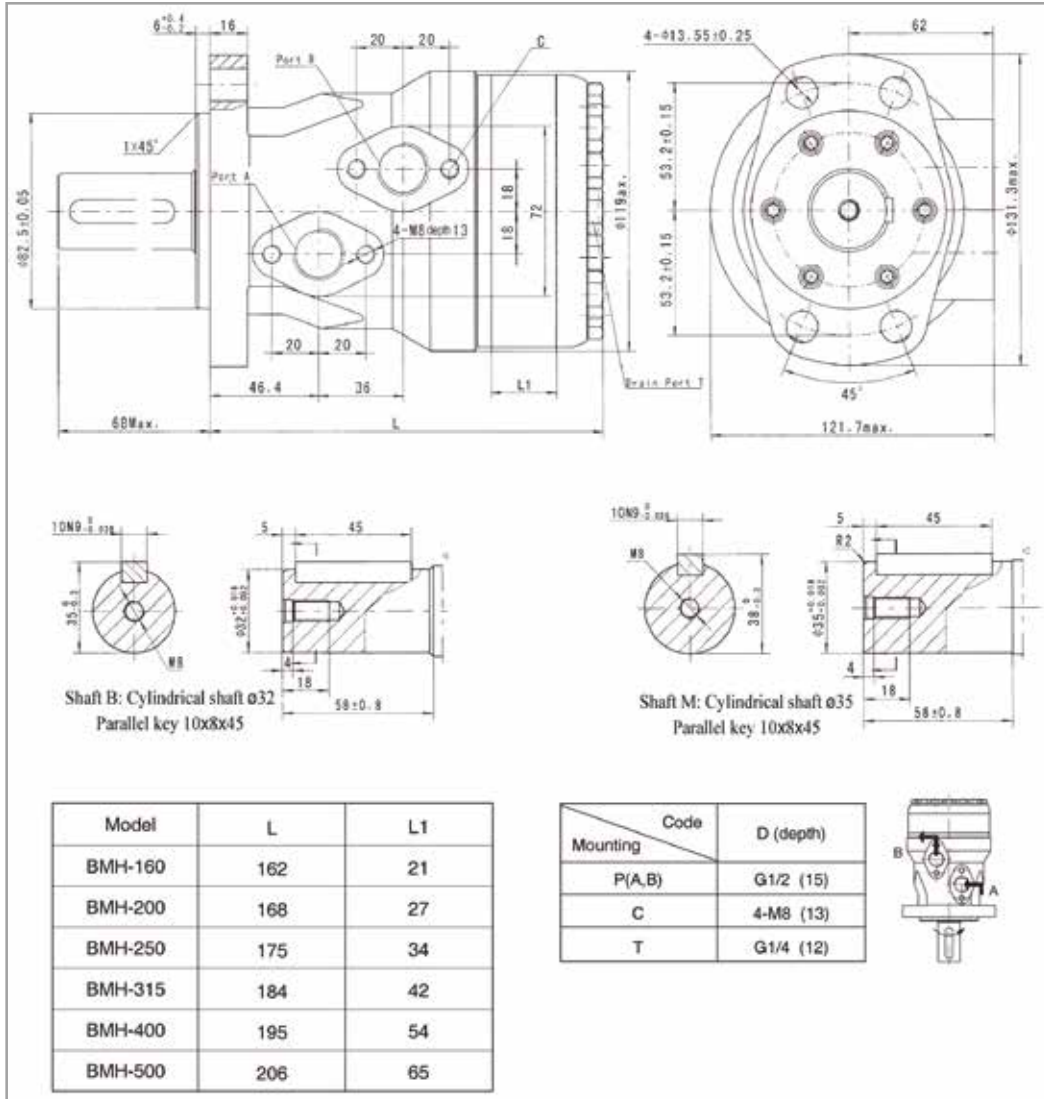

Hidromotor / BMS Model Ölçü ve Montaj Bilgisi



Model	Mil Çapı mm	Motor Depl. (cc/rev)	Dönüş Hızı (rpm)	Δp (bar)	Tork (Nm)	Debi (lt/dak)	Fiyat (USD)
BMS80	Ø32	80,6	800	205	225	65	324
BMS100	Ø32	100,8	748	205	290	75	331
BMS125	Ø32	125	600	205	365	75	339
BMS160	Ø32	154	470	210	485	75	342
BMS200	Ø32	194	375	210	586	75	345
BMS250	Ø32	243	300	200	708	75	360
BMS315	Ø32	311	240	200	880	75	369
BMS400	Ø32	394	185	160	880	75	376

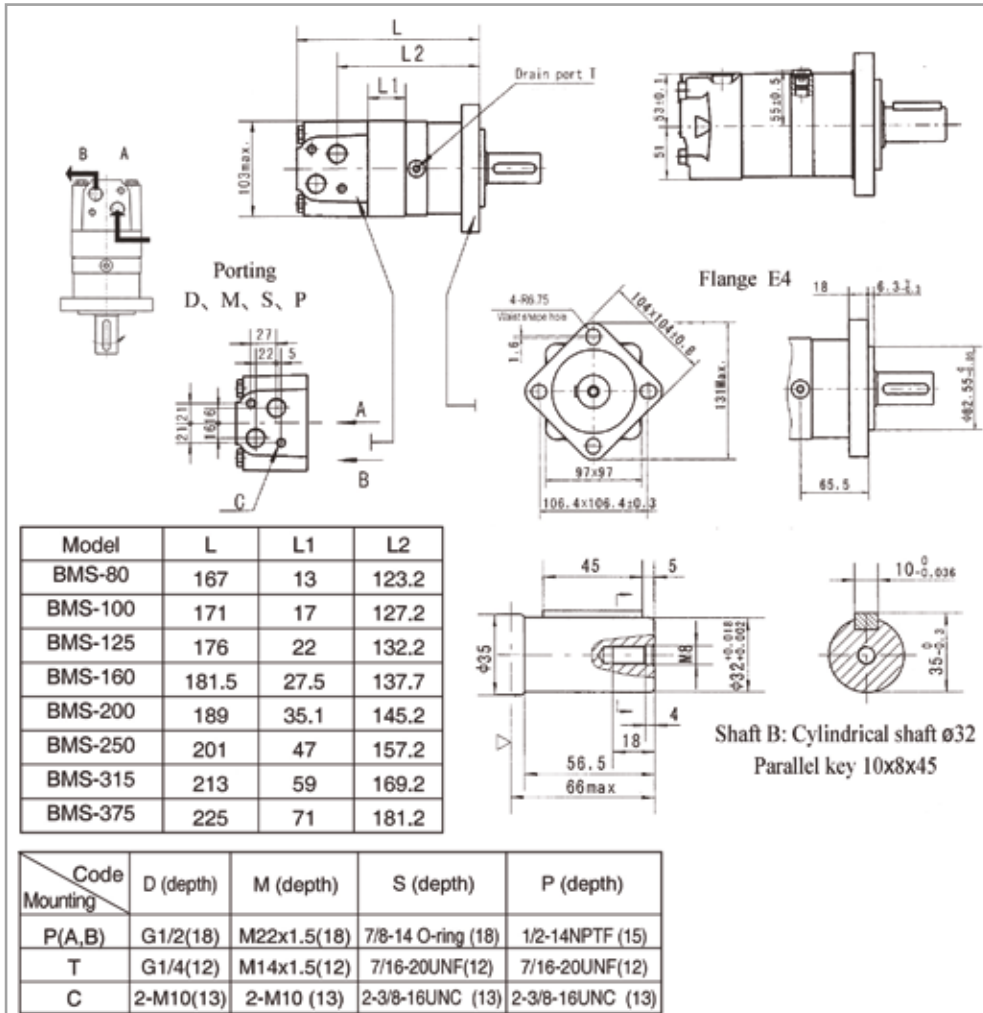

Hidromotor / BMV Model Ölçü ve Montaj Bilgisi



Model	Mil Çapı mm	Motor Depl. (cc/rev)	Dönüş Hızı (rpm)	Δp (bar)	Tork (Nm)	Debi (lt/dak)	Fiyat (USD)
BMV315	Ø50	333	510	200	920	160	669
BMV400	Ø50	419	500	200	1180	200	698
BMV500	Ø50	518	400	200	1460	200	740
BMV630	Ø50	666	320	180	1660	200	775
BMV800	Ø50	801	250	160	1880	200	873

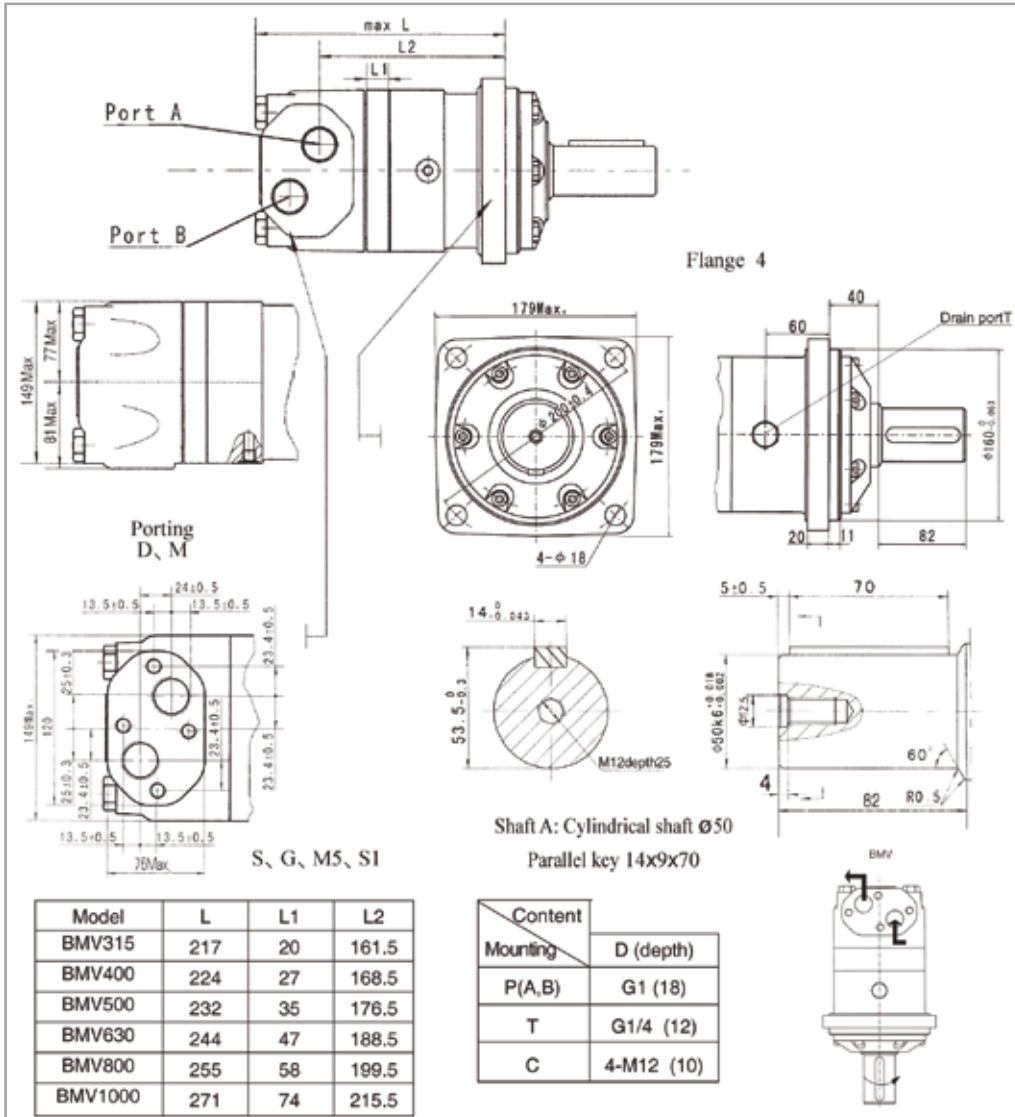

HİDROLİK







Soğutucular

Fanlı Soğutucular



FANLI SOĞUTUCULAR						
Model	Voltaj V	Soğutma Kapasitesi kcal/h	Debi lt/dak	Δp (bar)	Portlar Giriş-Çıkış	Fiyat (USD)
F2015	12 VDC	4000	80	24	1" BSP	301
	24 VDC					315
	220 VAC					347
F2020	12 VDC	5000	100	24	1" BSP	383
	24 VDC					398
	220 VAC					480
F2024	12 VDC	8500	120	24	1 1/4" BSP	484
	24 VDC					498
	220 VAC					624
F2030	12 VDC	12000	140	24	1 1/4" BSP	696
	24 VDC					888
	220 VAC					913
F2040	12 VDC	15000	160	24	1 1/4" BSP	888
	24 VDC					913
	220 VAC					
F2050	12 VDC	20000	200	24	1 1/4" BSP	
	24 VDC					
	220 VAC					

* Soğutucu fiyatlarına fan müşürü dahil **değildir**.

Soğutucu Fanları

SOĞUTUCU FANLARI			
Model	Voltaj V	Çap mm	Fiyat (USD)
SP.FAN 2015&2020	12 VDC	225	142
	24 VDC		
	220 VAC	200	
SP.FAN 2024	12 VDC	280	160
	24 VDC		
	220 VAC	250	
SP.FAN 2030	12 VDC	305	219
	24 VDC		
	220 VAC	300	
SP.FAN 2040	12 VDC	385	279
	24 VDC		
	220 VAC	400	
SP.FAN 2050	12 VDC *	280	160
	24 VDC *		
	220 VAC	450	356

* F2050 DC soğutucular çift fanlıdır. Verilen fiyat bir adet fan içindir



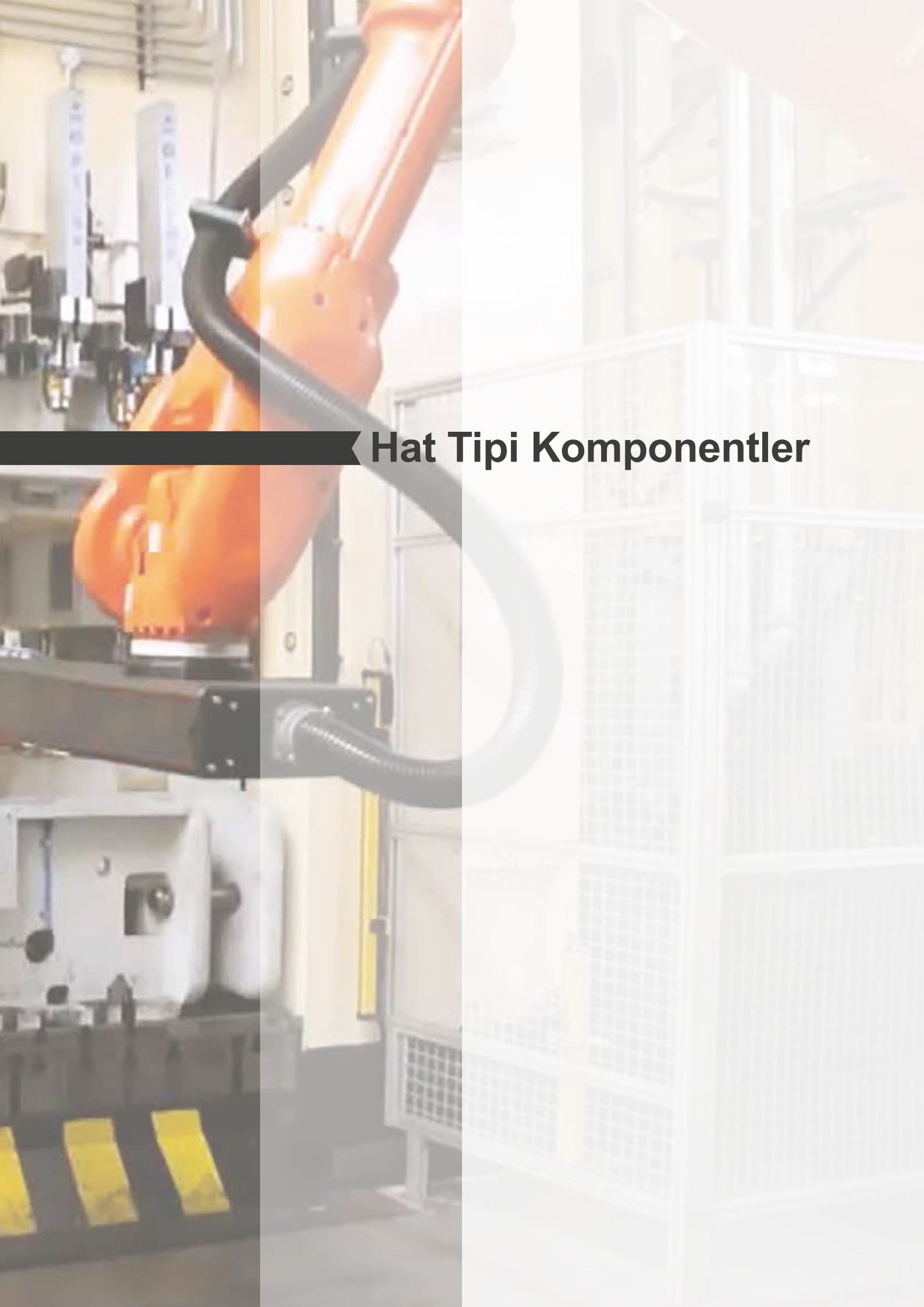

Hat Tipi Komponentler

Hidrolik Otomatik Rakor, Qc Serisi (Popetli)



Model	Tip	Ölçü	Basınç (bar)	Fiyat (TL)
QC-101	TAKIM * Galvaniz kapı karbon çelik * NBR keçeli	1/4"	350	52,5
QC-102		3/8"	330	53,63
QC-103(T)		1/2"(TOZ KAPAKLI)	320	56,6
QC-104		3/4"	280	97,18
QC-105		1"	250	137,65
QC-106		1 1/4"	230	188,67
QC-107		1 1/2"	220	444,28
QC-108		2"	200	1008,80

Hidrolik Döner Bağlantı Rakoru



Model	Tip	Ölçü	Basınç (bar)	Fiyat (TL)
DNB-14N	Düz Tip	1/4"	450	75,57
DNB-38N		3/8"	450	82,07
DNB-12N		1/2"	410	95,07
DNB-34N		3/4"	360	143,82
DNB-1N		1"	330	219,38
DNB-D-14N	Dirsek Tip	1/4"	450	82,07
DNB-D-38N		3/8"	450	95,07
DNB-D-12N		1/2"	410	117
DNB-D-34N		3/4"	360	208,82
DNB-D-1N		1"	330	291,70

Hidrolik Küresel Vana (2 Yollu)

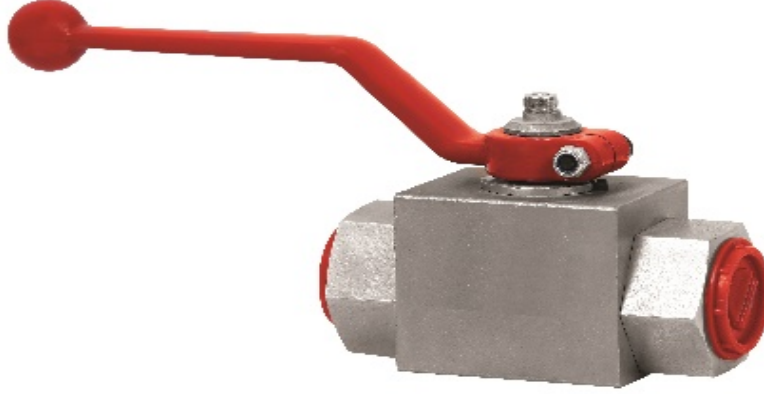

Model	Tip	Ölçü	Basınç (bar)	Fiyat (TL)
KV-2401	2 Yollu	1/4"	500	60
KV-2402		3/8"	500	64,85
KV-2403		1/2"	500	74,60
KV-2404		3/4"	400	133,10
KV-2405		1"	400	161,70
KV-2406		1 1/4"	400	216
KV-2407		1 1/2"	350	234,82

Hidrolik Küresel Vana (3 Yollu)

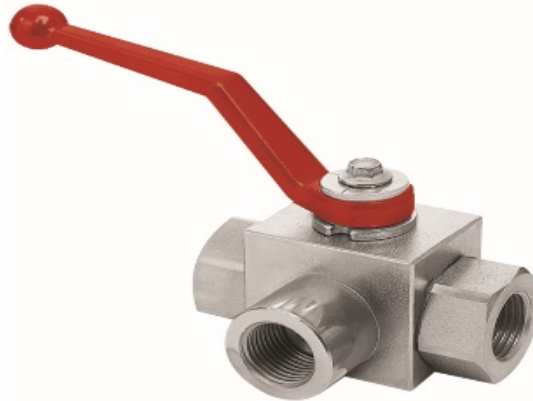

Model	Tip	Ölçü	Basınç (bar)	Fiyat (TL)
KV3L-401	3 Yollu, L Tipi	1/4"	500	122,70
KV3L-402		3/8"	500	131,63
KV3L-403		1/2"	500	148,70
KV3L-404		3/4"	400	258,38
KV3L-405		1"	400	306,32
KV3L-406		1 1/4"	400	383,50
KV3L-407		1 1/2"	380	420,88

Hidrolik Basınç Emniyet Valfi



Model	Tip	Ölçü	Fiyat (TL)
PS-401	Hat Tipi	1/2"	136,35

Hidrolik El Pompası



Model	Tip	Ölçü	Fiyat (TL)
OHP-501	Tek Tesirli El Pompası	25 cc	383,36
OHP-601		45 cc	447,62
OHP-502	Çift Tesirli El Pompası	25 cc	423,24
OHP-602		45 cc	480,86
OLC-AT-4001	El Pompası Deposu (Alüminyum)	1 Litre	158,45
OLC-AT-4002		2 Litre	220,50
OLC-AT-4003		3 Litre	299,6
OLC-AT-4004		4 Litre	351,00
OLC-AT-4005		5 Litre	393,55
OHP-K	El Poması Sapı		52,09

* El pompası fiyatlarına sap dahil, depo hariçtir.

Hidrolik Hat Tipi İkiz Kilit Valfi



Model	Tip	Ölçü	Basınç (bar)	Fiyat (TL)
TLV-301	Hat Tipi	1/4"	380	78
TLV-302		3/8"	380	78
TLV-303		1/2"	360	128,38

Hortum Patlama Valfi



Model	Tip	Ölçü	Fiyat (TL)
HPV-101	Komple (Gövde+Kartuş)	1/4"	67
HPV-102		3/8"	55,66
HPV-103		1/2"	64,20
HPV-104		3/4"	90,20
HPV-105		1"	168,85

Hidrolik Hat Tipi Çek Valf



Model	Tip	Ölçü	Basınç (bar)	Fiyat (TL)
CV-201	Hat Tipi	1/4"	450	35
CV-202		3/8"	450	35,75
CV-203		1/2"	400	36,57
CV-204		3/4"	380	75,57
CV-205		1"	350	131,63
CV-206		1 1/4"	350	177,13
CV-207		1 1/2"	280	209,63
CV-208		2"	260	290,88

FIRETECH



PNÖMATA

İçerik:

- ☐ Silindirler » 54-58
- ☐ Silindir Aksesuarları » 59-60
- ☐ Valfler » 61-68
- ☐ Şartlandırıcılar » 69-71
- ☐ Bağlantı Elemanları » 72-77
- ☐ Hava Tabancaları » 78
- ☐ Hortum Makası » 78





		Silindir Çapı (mm)					
		Ø32	Ø40	Ø50	Ø63	Ø80	Ø100
Strok (mm)	25	18,73	22,04	31,34	37,50	54,01	65,27
	50	18,96	24,20	34,05	41,77	55,36	73,16
	75	20,22	25,32	34,78	42,56	61,67	73,30
	100	21,52	26,49	38,29	44,32	62,41	76,51
	125	22,56	29,43	40,25	50,38	65,27	84,86
	150	24,63	30,24	42,35	50,38	71,62	85,96
	160	24,63	31,15	43,20	50,88	71,62	87,66
	200	26,71	32,93	46,36	54,94	78,48	92,03
	250	29,34	36,26	51,34	60,75	85,39	101,62
	300	31,97	41,56	56,19	66,43	92,99	110,35
	350	34,45	43,04	61,17	72,17	100,61	121,29
	400	37,09	46,36	66,15	77,91	108,28	127,61
	450	41,31	49,68	70,99	84,43	115,90	134,93
	500	42,28	53,00	76,73	90,44	123,57	143,65

Çalışma Basıncı : 1~9 bar
Dayanma Basıncı : 13,5 bar (max)
Çalışma Sıcaklığı : -5~70°C

RAL Serisi Sökülebilir Manyetik, Alüminyum Kalem Silindirler



		ÇAP			
(mm)		Ø16	Ø20	Ø25	Ø32
Strok (mm)	10	11,73			
	20		14,38		
	25	11,73	14,38	16,79	22,08
	40	12,54			
	50	12,54	15,99	18,06	20,01
	75	13,23	16,79	19,21	24,04
	100	13,92	15,87	20,01	25,07
	125	18,75	18,52	21,05	22,89
	150	20,13	17,37	22,08	28,06
	160		17,83		
	175	21,74	17,83	20,70	24,50
	200	22,77	18,75	21,74	26,22

Çalışma Basıncı : 1~9 bar
Dayanma Basıncı : 13,5 bar (max)
Çalışma Sıcaklığı : 0~70°C



		ÇAP (mm)			
		Ø12	Ø16	Ø20	Ø25
Strok (mm)	25	11,24	11,12	14,99	15,26
	30				17,02
	50	11,91	11,91	15,50	17,07
	75	12,26	12,26	16,08	17,37
	80	14,19	14,19	17,12	18,01
	100	13,10	12,98	17,20	19,02
	120	13,32			
	125	13,32	13,32	17,40	19,82
	150	14,11	14,11	17,47	20,66
	160		15,83	18,01	21,86
	175	15,26	15,26	19,39	22,10
	200	15,40	15,26	19,39	21,89

Çalışma Basıncı : 1~9 bar
Dayanma Basıncı : 13,5 bar (max)
Çalışma Sıcaklığı : 0~70°C

SD Kısa Strok Silindirler



		Silindir Çapı (mm)									
		Ø12	Ø16	Ø20	Ø25	Ø32	Ø40	Ø50	Ø63	Ø80	Ø100
Strok (mm)	5	7,86	8,27	8,41	10,49	11,70	14,69	17,40	22,60	31,36	45,97
	10	8,67	8,75	9,45	10,89	12,11	15,69	19,68	22,60	37,02	54,44
	15	9,15	9,15	10,08	11,42	13,04	15,97	20,96	23,91	37,31	54,44
	20	9,54	9,68	10,49	11,70	13,44	16,97	21,97	24,81	38,28	57,18
	25	9,94	9,94	10,89	12,57	14,39	17,83	22,74	26,06	40,13	57,18
	30	10,35	10,89	11,94	13,04	15,06	18,39	23,29	27,58	38,79	58,91
	35	10,89	11,70	12,23	13,85	15,47	19,25	23,29	28,28	40,07	58,91
	40	12,03	12,11	13,04	14,66	16,26	19,54	24,48	29,59	41,36	60,56
	45	12,44	13,59	14,78	16,14	18,02	21,82	27,12	32,84	45,84	60,56
	50	11,63	13,04	13,44	15,06	16,81	21,93	25,27	30,49	42,71	67,05

Çalışma Basıncı : 1~9 bar

Dayanma Basıncı : 10,5 bar (max)

Çalışma Sıcaklığı : 0~70°C

Döner Tabla Silindirleri

EMQ SERİSİ 0~190° Ayarlı, Döner Tabla Silindirleri

Tip	Fiyat (\$)
EMQB10S	75,00
EMQB20S	85,00
EMQB30S	105,00
EMQB50S	125,00
EMQB70S	190,00
EMQB100S	210,00

EMQ SERİSİ 0~190° Ayarlı, Şok Emicili Döner Tabla Silindirleri

Tip	Fiyat (\$)
EMQB20RS	85,00
EMQB30RS	105,00
EMQB50RS	125,00
EMQB70RS	190,00
EMQB100RS	210,00



FVBC Tipi Silindir Montaj Malzemeleri

Fotoğraf	Tanımı	MODEL	Fiyat (\$)	Fotoğraf	Tanımı	MODEL	Fiyat (\$)		
	VFA /FB Flanş Bağlantı	Ø32	5,33		VY Çatal Bağlantı	Ø12/Ø16 - M6x1	0,6		
		Ø40	5,3			Ø25/Ø32 - M10x1,25	1,0		
		Ø50	7,62			Ø40 - M12x1,25	1,25		
		Ø63	9,34			Ø50/Ø63 - M16x1,5	2,25		
		Ø80	14,81			Ø80/Ø100 - M20x1,5	4		
		Ø100	18,68			Ø160 - M36x2,0	20		
		Ø125	31,87			Ø200 - M36x2,0	20		
		Ø160	51			Ø250 - M42x2,0	70		
		Ø200	70,13						
	VCA Eklem Bağlantısı	Ø32	1		VYC Tip Klipsli Çatal Bağlantı	Ø12/Ø16 - M6x1	2,03		
		Ø40	1,1			Ø20 - M8x1,25	NET FİYAT 0,9		
		Ø50	1,3			Ø25/Ø32 - M10x1,25	3,62		
		Ø63	1,75			Ø40 - M12x1,25	4,96		
		Ø80	2,5			Ø50/Ø63 - M16x1,5	8,18		
		Ø100	3,75			Ø80/Ø100 - M20x1,5	15,23		
		Ø125	6						
		Ø160	15			Ø125 - M27x2,0	14		
		Ø200	25						
	VCB Eklem Bağlantı (Pimli Tip, VCR yer bağlantısı ile kullanılabilir)	Ø32	2,67		VLB Ayak Bağlantı	Ø32	NET FİYAT 0,35		
		Ø40	3,3			Ø40	0,5		
		Ø50	5,11			Ø50	0,7		
		Ø63	6,13			Ø63	1,05		
		Ø80	9,95			Ø80	1,2		
		Ø100	15,1			Ø100	1,4		
		Ø125	9,3			Ø125	2,6		
		Ø160	16			Ø160	7,5		
		Ø200	25			Ø200	12		
	VB Hareketli Mafsals	Ø10 - M4	2,18		VCR Yer Bağlantısı (VCB tipi eklem bağlantısı ile kullanılabilir)	Ø32	5,3		
		Ø12/Ø16 - M6x1	2,49			Ø40	6,1		
		Ø20 - M8x1,25	2,78			Ø50	8,03		
		Ø25/Ø32 - M10x1,25	3,01			Ø63	8,78		
		Ø40 - M12x1,25	3,92			Ø80	12,14		
		Ø50/Ø63 - M16x1,5	5,34			Ø100	17,16		
		Ø80/Ø100 - M20x1,5	9,67			Ø125	NET FİYAT 7,5		
		Ø125 - M27x2,0	26,55			Ø160	14		
		Ø160 - M36x2,0	17,5	Ø200	31				
		Ø200 - M36x2,0	17,5						
			VF Kasıntı Alıcı					Ø32 - M10x1,25	8,2
								Ø40 - M12x1,25	8,41
				Ø50/Ø63 - M16x1,5	17,55				
				Ø80/Ø100 - M20x1,5	23,22				

IAS Tipi Silindir Montaj Malzemeleri

Fotoğraf	Tanımı	MODEL	Fiyat (\$)	Fotoğraf	Tanımı	MODEL	Fiyat (\$)	
	ISDB Eklem Bağlantı	Ø12	0,50		IFA Flamş Bağlantı	Ø12	0,40	
		Ø16	0,50			Ø16	NET FİYAT	0,40
		Ø20	0,55					
		Ø25	0,55					
	ILB Ayak Bağlantı	Ø16	0,40		VI Çatal Bağlantı	Ø20	0,40	
		Ø20	0,40			Ø25	NET FİYAT	0,40
		Ø25	0,40					

Manyetik Sensörler

Tanımı	Model	Fotoğraf	Fiyat (\$)
FVBC TİP SİLİNDİRLER İÇİN	HX-31R(Reed Switch)		6,46
IAS VE RAL TİPİ SİLİNDİRLER İÇİN	HX-03R (Reed S. 1mt.)		6,38
	HX-03R (Reed S. 3mt.)		7,04
	HX-03P(PNP)		21,19
	HX-15R(Reed Switch)		7,70
SD TİP SİLİNDİRLER İÇİN	CS1-J (Reed Switch)		5,80



V Serisi Elektrik Uyarılı Yön Kontrol Valfleri

Tanımı	Fotoğraf	Model	Gövde Ölçüsü	Port Ölçüsü	Fiyat (\$)
3/2 Tek Bobin		V3211-06	1/8	G1/8	10,37
		V3221-08	1/4	G1/4	9,08
		V3231-10	3/8	G3/8	16,76
		V3231-08	3/8	G1/4	15,11
		V3241-15	1/2	G1/2	23,08
5/2 Tek Bobin		V5211-06	1/8	G1/8	11,25
		V5221-06	1/4	G1/8	13,08
		V5221-08	1/4	G1/4	8,71
		V5231-10	3/8	G3/8	16,86
		V5231-08	3/8	G1/4	15,47
5/2 Çift Bobin		V5241-15	1/2	G1/2	21,92
		V5212-06	1/8	G1/8	17,93
		V5222-08	1/4	G1/4	15,12
		V5232-10	3/8	G3/8	23,16
		V5232-08	3/8	G1/4	23,16
5/3 Çift Bobin (Kapalı Merkez)		V5242-15	1/2	G1/2	27,99
		V5312-06C	1/8	G1/8	19,59
		V5322-08C	1/4	G1/4	20,95
		V5332-10C	3/8	G3/8	31,57
		V5332-08C	3/8	G1/4	37,90
5/3 Çift Bobin (Basınç Merkez)		V5342-15C	1/2	G1/2	35,53
		V5312-06P	1/8	G1/8	22,49
		V5322-08P	1/4	G1/4	24,09
5/3 Çift Bobin (Egzos Merkez)		V5332-10P	3/8	G3/8	36,31
		V5342-15P	1/2	G1/2	38,92
		V5312-06E	1/8	G1/8	22,49
		V5322-08E	1/4	G1/4	24,09
3/2 Tek Bobin (Normalde Açık)		V5332-10E	3/8	G3/8	36,31
		V5342-15E	1/2	G1/2	38,92
		V3221-08H	1/4	G1/4	11,40
5/2 Tek Bobin (Kablolu Tip)		V3241-15H	1/2	G1/2	26,40
		V5221-06F	1/4	G1/8	11,63
		V5221-08F	1/4	G1/4	11,63

* Lütfen siparişinizde model kodundan sonra voltaj kodunu ekleyiniz. 24 VDC için "E4", 220 VAC için "E2".

* Fiyatlara bobin ve ışıklı soketler DAHİLDİR

Çalışma Basıncı : 1.5~8 bar

Dayanma Basın : 12 bar (max)

Çalışma Sıcaklığı : 5~50°C

Güç Tüketimi : AC-2.5VA / DC-2.5W (1/8" Gövde) - AC-4.5VA / DC-3W (1/4", 3/8" ve 1/2" Gövde)

Frekans : 20 Hz (max)

Fiyatlarımız USD cinsindedir.

V Serisi Namur ve Hava Uyarılı Yön Kontrol Valfleri

Tanımı	Fotoğraf	Model	Gövde Ölçüsü	Port Ölçüsü	USD Fiyat
3/2 Tek Bobin Namur Valf		V3231-08M	3/8	G1/4	18,36
5/2 Tek Bobin Namur Valf		V5221-08M	1/4	G1/4	11,66
		V5231-08M	3/8	G1/4	15,12
5/2 Çift Bobin Namur Valf		V5232-08M	3/8	G1/4	30,61
3/2 Hava-Yay		V3211-06A	1/8	G1/8	8,82
		V3221-08A	1/4	G1/4	7,82
		V3231-10A	3/8	G3/8	14,48
		V3241-15A	1/2	G1/2	16,30
5/2 Hava-Yay		V5211-06A	1/8	G1/8	12,70
		V5221-06A	1/4	G1/8	12,70
		V5221-08A	1/4	G1/4	7,82
		V5231-08A	3/8	G1/4	10,27
		V5231-10A	3/8	G3/8	13,79
		V5241-15A	1/2	G1/2	19,55
5/2 Hava-Hava		V5212-06A	1/8	G1/8	14,40
		V5222-08A	1/4	G1/4	10,56
		V5232-10A	3/8	G3/8	18,44
		V5242-15A	1/2	G1/2	21,30
5/3 Hava-Hava (Kapalı Merkez)		V5312-06AC	1/8	G1/8	18,00
		V5322-08AC	1/4	G1/4	12,58
		V5332-10AC	3/8	G3/8	27,60
		V5342-15AC	1/2	G1/2	34,92
5/3 Hava-Hava (Basınç Merkez)		V5312-06AP	1/8	G1/8	18,00
		V5322-08AP	1/4	G1/4	12,58
		V5332-10AP	3/8	G3/8	27,60
		V5342-15AP	1/2	G1/2	34,92
5/3 Hava-Hava (Egzos Merkez)		V5312-06AE	1/8	G1/8	18,00
		V5322-08AE	1/4	G1/4	12,58
		V5332-10AE	3/8	G3/8	27,60
		V5342-15AE	1/2	G1/2	34,92

* Lütfen namur valfler için, siparişinizde model kodundan sonra voltaj kodunu ekleyiniz. 24 VDC için "E4", 220 VAC için "E2".

* Fiyatlara bobin ve ışıklı soketler DAHİLDİR

Çalışma Basıncı : 1.5~8 bar

Dayanma Basıncı : 12 bar (max)

Çalışma Sıcaklığı : 5~50°C

Frekans : 20 Hz (max)

Fiyatlarımız USD cinsindedir.

Valfler

V Serisi Yüksek Frekans Valfleri

Tanımı	Fotoğraf	Model	Ölçü	USD Fiyat
CN Serisi Düşük Güç/ Yüksek Frekans Valfleri		CN2V251-08	G1/4	23,40

Valf Yedek Parçaları

Tanımı	Fotoğraf	Model	Fiyat (\$)
Zamanlayıcı		PUT	15,13
Valf Bobini - 1/8" gövde için (Işıklı Soket Dahil)		VC1-DT	3,83
Valf Bobini - 1/4", 3/8", 1/2" gövde için (Işıklı Soket Dahil)		VC2-DT	3,66

* Lütfen siparişinizde model kodundan sonra voltaj belirtiniz. 12, 24 ve 220 volt AC/DC bobinler stoklarımızda mevcuttur.

V serisi Valfler için Manifoltlar















MANIFOLT 3/2 Valf ler için	SIRALI	1/8"		1/4"		3/8"		1/2"	
	2	V321-2F	5,76	V322-2F	3,96	V323-2F	11,99	V324-2F	12,65
3	V321-3F	8,62	V322-3F	5,94	V323-3F	17,97	V324-3F	18,70	
4	V321-4F	13,94	V322-4F	7,92	V323-4F	23,97	V324-4F	24,64	
5	V321-5F	17,44	V322-5F	9,90	V323-5F	30,02	V324-5F	30,80	
6	V321-6F	20,92	V322-6F	11,88	V323-6F	30,02	V324-6F	40,26	
7	V321-7F	24,42	V322-7F	13,86	V323-7F	31,90	V324-7F	68,53	
8	V321-8F	27,86	V322-8F	15,84	V323-8F	38,50	V324-8F	78,32	
9	V321-9F	31,36	V322-9F	17,82	V323-9F	44,00	V324-9F	88,11	
10	V321-10F	32,53	V322-10F	19,80	V323-10F	60,04	V324-10F	97,90	

MANIFOLT 5/2 ve 5/3 Valfler için	SIRALI	1/8"		1/4"		3/8"		1/2"	
	2	V521-2F	3,96	V522-2F	3,96	V523-2F	6,40	V524-2F	12,11
3	V521-3F	5,94	V522-3F	5,94	V523-3F	10,49	V524-3F	16,64	
4	V521-4F	7,92	V522-4F	7,92	V523-4F	14,00	V524-4F	23,05	
5	V521-5F	9,90	V522-5F	9,90	V523-5F	15,37	V524-5F	31,83	
6	V521-6F	11,88	V522-6F	11,88	V523-6F	18,57	V524-6F	40,26	
7	V521-7F	13,86	V522-7F	13,86	V523-7F	21,77	V524-7F	68,53	
8	V521-8F	15,84	V522-8F	15,84	V523-8F	24,33	V524-8F	78,32	
9	V521-9F	17,82	V522-9F	17,82	V523-9F	27,53	V524-9F	88,11	
10	V521-10F	19,80	V522-10F	19,80	V523-10F	30,73	V524-10F	97,90	

Not: Sızdırmazlık contası ve civatalar DAHİLDİR.

Fiyatlarımız USD cinsindedir.

Mekanik Valfler

Tanımı	Fotograf	Model	Fiyat (\$)	
1/4" - 3/2 Mekanik Uyarılı Valfler	Çevirmeli		M322-S1	13,11
	Makaralı		M322-S2	
	Acil Stop (Çevirmeli Reset)		M322-S3	
	Butonlu (Konkav Tip)		M322-S4	
	Butonlu (Düz Tip)		M322-S5	
	Butonlu (Mantar Tip)		M322-S6	
1/4" - 5/2 Mekanik Uyarılı Valfler	Çevirmeli		M522-S1	10,98
	Makaralı		M522-S2	
	Acil Stop (Çevirmeli Reset)		M522-S3	
	Butonlu (Konkav Tip)		M522-S4	
	Butonlu (Düz Tip)		M522-S5	
	Butonlu (Mantar Tip)		M522-S6	

L/H Serisi Mekanik Kumandalı Valfler

Tanımı	Fotoğraf	Model	Gövde Ölçüsü	Port Ölçüsü	Fiyat (\$)	
3/2 Düğmeli, Kalmalı Tip		L321-06	1/8	G1/8	11,28	
		L322-08	1/4	G1/4	11,75	
		L323-08	3/8	G1/4	14,22	
		L323-10	3/8	G3/8	17,46	
		L324-15	1/2	G1/2	22,12	
5/2 Düğmeli, Kalmalı Tip		L521-06	1/8	G1/8	11,28	
		L522-08	1/4	G1/4	11,75	
		L523-08	3/8	G1/4	14,34	
		L523-10	3/8	G3/8	17,93	
		L524-15	1/2	G1/2	24,50	
3/2 Kollu, Kalmalı Tip			H321-06	1/8	G1/8	16,34
			H322-08	1/4	G1/4	16,43
			H323-08	3/8	G1/4	19,44
			H323-10	3/8	G3/8	19,44
			H324-15	1/2	G1/2	25,92
5/2 Kollu, Kalmalı Tip	H521-06		1/8	G1/8	16,34	
	H522-08		1/4	G1/4	11,11	
	H523-08		3/8	G1/4	13,29	
	H523-10		3/8	G3/8	16,12	
	H524-15		1/2	G1/2	27,43	
5/2 Kollu, Yay Geri Dönüştü Tip	H521-06S		1/8	G1/8	16,91	
	H522-08S		1/4	G1/4	16,91	
	H523-08S		3/8	G1/4	21,98	
	H523-10S		3/8	G3/8	22,69	
	H524-15S		1/2	G1/2	28,28	
5/3 Kollu, Yay Geri Dönüştü Tip (Kapalı Merkez)	H531-06S	1/8	G1/8	22,44		
	H532-08S	1/4	G1/4	21,52		
	H533-08S	3/8	G1/4	28,45		
	H533-10S	3/8	G3/8	27,43		
	H534-15S	1/2	G1/2	46,80		
5/3 Kollu, Kalmalı Tip (Kapalı Merkez)	H531-06C	1/8	G1/8	24,50		
	H532-08C	1/4	G1/4	21,52		
	H533-08C	3/8	G1/4	28,45		
	H533-10C	3/8	G3/8	28,04		
	H534-15C	1/2	G1/2	46,80		

Çalışma Basıncı : 1.5~8 bar
 Dayanma Basıncı : 12 bar (max)
 Çalışma Sıcaklığı : -5~80°C

Fiyatlarımız USD cinsindedir.

Pedal ve Kol Kumandalı Valfler

Tanımı	Fotoğraf	Model	Gövde Ölçüsü	Port Ölçüsü	FİYAT (USD)
3/2 Pedal-Yay		F322-08		G1/4	11,17
5/2 Pedal-Yay		F522-08		G1/4	25,27
5/2 Pedal-Yay Kilitli Tip		F522-08L		G1/4	28,80
5/2 Pedal-Yay Korumalı Tip		F522C-08		G1/4	32,26
4/3 El Kumandalı, Çevirmeli Valf		R432-08	1/4	G1/4	14,64
		R432-10		G3/8	14,64
		R432-15		G1/2	14,64
		U432-08		G1/4	14,64
		M432-08		G1/4	14,31
4/3 El Kumandalı, Çevirmeli Valf (Seramik Keçeli)		MR432-08	1/4	G1/4	23,06
		MR432-10		G3/8	23,06
		MR432-15		G1/2	23,06

Valf Aksesuarları

Tanımı	Foto	Model	Port Ölçüsü	Fiyat (USD)
Çek Valf		EA-06	G1/8	6,16
		EA-08	G1/4	6,16
		EA-10	G3/8	11,69
		EA-15	G1/2	11,79
Çabuk Egzos		KKP-06	G1/8	10,51
		KKP-08	G1/4	10,51
		KKP-10	G3/8	11,80
		KKP-15	G1/2	15,69
VEYA valfi		ES-06	G1/8	8,64
		ES-08	G1/4	8,64
		ES-10	G3/8	13,97
		ES-15	G1/2	13,97
Hız Ayar Valf (Çekli)		RE-01	G1/8	4,30
		RE-02	G1/4	4,30
		RE-03	G3/8	6,71
		RE-04	G1/2	6,71
Slide Valf		YHS-06	G1/8	5,41
		YHS-08	G1/4	6,71
		YHS-10	G3/8	9,78
		YHS-15	G1/2	11,82

SLP Serisi Solenoid Valfler (NK)









Fotoğraf	Ölçü	Orifis (mm)	Keçe	Gövde Malzemesi	Model	Fiyat (USD)
	1/8" **	3	NBR	Pirinç	SLP06-3L	27,42
	1/4" **	3	NBR	Pirinç	SLP08-3L	28,38
	3/8"	10.5	NBR	Pirinç	SLP10-10,5L	41,11
	1/2"	13	NBR	Pirinç	SLP15-13L	45,40
	3/4"	20	NBR	Pirinç	SLP20-20L	55,08
	1"	25	NBR	Pirinç	SLP25-25L	81,02
	1-1/4"	35	NBR	Pirinç	SLP35-35L	157,37
	1-1/2"	40	NBR	Pirinç	SLP40-40L	157,37
	2"	50	NBR	Pirinç	SLP50-50L	234,30

** Paslanmaz SS316 olarak stokta mevcuttur, lütfen fiyat sorunuz

SLP-H Serisi Solenoid Valfler (NA)

Fotoğraf	Ölçü	Orifis (mm)	Keçe	Gövde Malzemesi	Model	Fiyat (USD)
	1/8"	3	NBR	Pirinç	SLP06-3LH	44,12
	1/4"	3	NBR	Pirinç	SLP08-3LH	44,12
	3/8"	13	NBR	Pirinç	SLP10-13LH	72,19
	1/2"	13	NBR	Pirinç	SLP15-13LH	72,19
	3/4"	20	NBR	Pirinç	SLP20-20LH	83,87
	1"	25	NBR	Pirinç	SLP25-25LH	104,83
	1-1/4"	35	NBR	Pirinç	SLP35-35LH	190,49
	1-1/2"	40	NBR	Pirinç	SLP40-40LH	190,49
	2"	50	NBR	Pirinç	SLP50-50LH	276,21

F Serisi Şartlandırıcılar

Tanımı	Foto	Ölçü	Model	Fiyat (USD)
İkili Şartlandırıcı (Filtre-Regülatör-Yağlayıcı) FR+L		G1/8"	FEC 1/8 MINI	46,00
		G1/4"	FEC 1/4 MINI	45,00
			FEC 1/4 D MINI (O.T.) *	60,30
		G3/8"	FEC 3/8 MIDI	69,55
			FEC 3/8 D MIDI (O.T.) *	88,74
		G1/2"	FEC 1/2 MIDI	69,55
			FEC 1/2 D MIDI (O.T.) *	88,74
G3/4"	FEC 3/4 MAXI	162,50		
Filtre-Regülatör FR		G1/8	FEW 1/8 MINI	26,00
		G1/4	FEW 1/4 MINI	26,00
			FEW 1/4 MIDI	45,60
		G3/8	FEW 3/8 MIDI	39,73
		G1/2	FEW 1/2 MIDI	39,73
		G3/4	FEW 3/4 MAXI	69,60
		G1	FEW 1 MAXI	69,60
Filtre		G1/8	FEF 1/8" MINI	16,44
		G1/4	FEF 1/4" MINI	16,44
		G3/8	FEF 3/8" MIDI	23,12
		G1/2	FEF 1/2" MIDI	27,95
		G3/4	FEF 3/4" MAXI	48,00
		G1	FEF 1" MAXI	48,00
Yağlayıcı		G1/8	FEL 1/8" MINI	14,59
		G1/4	FEL 1/4" MINI	14,59
		G3/8	FEL 3/8" MIDI	25,14
		G1/2	FEL 1/2" MIDI	25,14
		G3/4	FEL 3/4" MAXI	49,00
		G1	FEL 1" MAXI	49,00
Regülatör		G1/8	FER 1/8 MINI	24,28
		G1/4	FER 1/4 MINI	24,28
			FER 1/4 MIDI	41,80
		G3/8	FER 3/8 MIDI	36,40
		G1/2	FER 1/2 MIDI	36,40
		G3/4	FER 3/4 MAXI	55,41
Filtre-Regülatör (40 Bar)		G1/4	FRH08 (1/4)	114,00
		G3/8	FRH10 (3/8)	114,00
		G1/2	FRH15 (1/2)	114,00
		G3/4	FRH20 (3/4)	191,00
Regülatör (40 Bar)		G1/4	FTHY08 (1/4)	35,00
		G3/8	FTHY10 (3/8)	35,00
		G1/2	FTHY15 (1/2)	35,00
		G3/4	FTHY20 (3/4)	89,00
Otomatik Tahliye Kiti			OTO.TAH.KITI-MINI	23,63
			OTO.TAH.KITI-MIDI	23,63

* O.T. : Otomatik Tahliyeli

Regülatör Ayar Basıncı : 0.5~12 bar (FRH ve FTHY 0.5~30 bar)

Max. Giriş Basıncı : 16 bar (FRH ve FTHY 40 bar)

Çalışma Sıcaklığı : 5~60°C

Filtre Hassasiyeti : 40 µm

AE/BE Serisi Şartlandırıcılar

Tanımı	Foto	Ölçü	Model	Fiyat (USD)
İkili Şartlandırıcı (Filtre-Regülatör- Yağlayıcı) FR+L		G1/4	AEFC2000	13,95
		G3/8	BEFC3000	34,18
		G1/2	BEFC4000	26,88
Filtre-Regülatör FR		G1/4	AFR2000	10,24
		G3/8	BEFR3000	20,91
		G1/2	BEFR4000	16,97
Filtre		G1/4	AEF2000	5,59
		G3/8	BEF3000	12,85
		G1/2	BEF4000	11,17
Yağlayıcı		G1/4	AEL2000	5,59
		G3/8	BEL3000	12,02
		G1/2	BEL4000	12,02
Regulator		G1/4	AER2000	6,98
		G1/4	BER2000	9,78
		G3/8	BER3000	9,78
		G1/2	BER4000	10,86

* Tüm filtreler yarı-otomatik tahliyelidir.

Regülatör Ayar Basıncı : 0.5~8.5 bar

Max. Giriş Basıncı : 9.5 bar

Çalışma Sıcaklığı : 5~60°C

Filtre Hassasiyeti : 40 µm

Fiyatlarımız USD cinsindedir.

E Serisi Şartlandırıcılar







Tanımı	Foto	Ölçü	Model	Fiyat (USD)
İkili Şartlandırıcı (Filtre-Regülatör- Yağlayıcı) FR+L		G1/8	EC2010-01	30,36
		G1/4	EC2010-02	24,85
		G3/8	EC3010-03	43,00
		G1/2	EC4010-04	66,66
		G3/4	EC5010-06	91,70
		G1	EC5010-10	91,70
Filtre-Regülatör FR		G1/4	EW2000-02	13,44
		G3/8	EW3000-03	28,36
		G1/2	EW4000-04	35,52
		G3/4	EW5000-06	53,29
		G1	EW5000-10	53,29
Filtre		G1/4	EF2010-02	6,83
		G3/8	EF3010-03	11,95
		G1/2	EF4010-04	15,77
		G3/4	EF5010-06	28,87
		G1	EF5010-10	28,87
Yağlayıcı		G1/4	EL2010-02	6,85
		G3/8	EL3010-03	11,19
		G1/2	EL4010-04	16,14
		G3/4	EL5010-06	29,33
		G1	EL5010-10	29,33
Regülatör		G1/4	ER2000-02	11,51
		G3/8	ER3000-03	20,84
		G1/2	ER4000-04	27,06
		G3/4	ER5000-06	45,36
		G1	ER5000-10	45,36

NOT: G1/4 gövdelerde korumalı tip kavanoz bulunmamaktadır







Regülatör Ayar Basıncı : 0.5~8.5 bar

Max. Giriş Basıncı : 10 bar

Bağlantı Elemanları - Plastik

	EPC Düz Rakor	EPCF Dişi Rakor	EPL Döner Dirsek	EPLF Dişi Döner Dirsek	EPLL Uzun Döner Dirsek	EPB Orta Bacak "T"
Ölçü						
3-M3	0,83	0,94	1,21	-	-	1,56
3-M5	0,85	0,94	1,21	-	-	1,56
4-M3	0,73	0,94	1,10	-	-	1,56
4-M5	0,48	0,94	0,61	-	-	1,05
4-M6	0,48	1,52	0,61	-	-	1,18
4-1/8"	0,48	0,94	0,62	-	-	1,07
4-1/4"	0,51	0,94	0,70	-	-	1,43
4-3/8"	0,77	1,27	-	-	-	1,56
4-1/2"	1,62	3,67	-	-	-	1,95
6-M5	0,46	0,77	0,60	-	-	0,86
6-1/8"	0,46	0,69	0,63	0,89	1,02	0,91
6-1/4"	0,53	0,91	0,79	0,96	1,18	1,05
6-3/8"	0,77	1,25	0,93	2,00	1,64	1,20
6-1/2"	1,36	1,17	1,55	2,42	2,45	1,86
8-1/8"	0,51	0,69	0,77	0,91	1,18	1,08
8-1/4"	0,56	0,91	0,80	1,01	1,39	1,17
8-3/8"	0,77	1,01	1,02	2,12	1,85	1,55
8-1/2"	1,38	1,40	1,65	2,64	2,45	1,50
9-1/4"	0,75	-	0,90	-	-	-
10-1/8"	0,76	1,03	1,17	1,62	1,39	1,25
10-1/4"	0,81	1,03	1,17	1,25	1,60	1,50
10-3/8"	0,84	1,19	1,21	2,51	1,99	1,92
10-1/2"	1,32	1,66	1,85	3,04	2,61	2,20
12-1/8"	1,11	1,27	1,74	2,98	3,37	2,05
12-1/4"	1,17	1,27	1,73	2,08	2,31	1,90
12-3/8"	1,19	1,27	1,77	2,76	1,99	2,10
12-1/2"	1,33	1,65	1,90	3,31	2,70	2,21
14-1/8"	-	3,17	-	-	-	-
14-1/4"	2,45	2,94	3,53	-	-	-
14-3/8"	2,94	3,53	4,07	-	-	4,65
14-1/2"	3,30	4,58	4,31	-	-	4,65
15-3/8"	-	-	-	-	-	4,65
15-1/2"	-	-	-	-	-	4,65
16-1/4"	-	-	4,20	-	-	-
16-3/8"	2,77	4,74	4,20	-	-	4,65
16-1/2"	2,77	4,88	4,20	-	-	4,65

Bağlantı Elemanları - Plastik

	EPD Yan Bacak "T"	EPWT Orta Bacak "Y"	EPHF Açık Döner Dirsek	EPKB Çoklu Dağıtıcı	ESC Hız Ayarlı Döner Dirsek	EHVFS Küresel Vana
Ölçü						
3-M3	1,68	-	-	-	-	-
3-M5	1,68	-	-	-	-	-
4-M3	1,47	0,91	-	-	-	-
4-M5	0,96	0,91	-	-	1,80	-
4-M6	0,96	-	-	-	-	-
4-1/8"	0,90	0,92	1,70	1,93	1,72	-
4-1/4"	0,90	1,14	1,80	2,17	2,30	-
6-M5	0,90	0,94	-	-	1,72	-
6-M6	1,01	-	1,00	-	-	-
6-1/8"	0,92	1,18	1,27	1,93	1,91	4,11
6-1/4"	1,36	0,89	1,75	1,96	2,17	4,35
6-3/8"	1,40	1,18	1,75	2,09	3,61	4,59
6-1/2"	1,36	1,53	2,70	-	4,00	5,50
8-1/8"	1,30	0,91	1,20	2,42	1,97	4,11
8-1/4"	1,30	0,91	1,31	2,42	2,17	4,35
8-3/8"	1,60	1,74	1,70	2,42	3,83	4,59
8-1/2"	2,00	1,92	2,70	-	4,04	5,50
10-1/8"	1,30	1,49	-	-	2,82	5,64
10-1/4"	1,30	1,49	1,73	-	2,82	6,77
10-3/8"	1,60	1,85	1,94	-	3,14	7,01
10-1/2"	2,00	2,25	2,90	-	3,70	7,25
12-1/8"	1,40	-	-	-	2,39	-
12-1/4"	1,60	1,69	1,79	-	2,60	-
12-3/8"	1,80	2,14	1,92	-	3,49	-
12-1/2"	2,00	2,14	2,90	-	4,24	-
14-1/8"	-	3,37	-	-	-	-
14-1/4"	-	4,72	-	-	-	-
14-3/8"	3,11	4,72	-	-	-	-
14-1/2"	3,30	4,72	-	-	-	-
16-3/8"	-	4,27	-	-	5,20	-
16-1/2"	-	4,94	-	-	5,20	-

Bağlantı Elemanları

	EPW Redüksiyon "Y" (1*D1-2*D2) Ör: 6-8-6	EPG Redüksiyon Nipel (1*D1-1*D2)	EPGJ Borulu Redüksiyon (1*D1-1*D2)	EPEG Yükseltici "T" (1*D2-2*D1) Ör: 8-6-8	EPKG Redüksiyon Kollektör (2*D1-3*D2) Ör: 8-6-6-8	EPEW Redüksiyon "T" (1*D1-2*D2) Ör: 6-8-6
Ölçü D1-D2						
6-4	0,54	0,45	0,70	0,61	1,50	0,68
8-4	-	0,53	-	0,66	1,73	1,03
8-6	0,63	0,51	0,78	0,66	1,73	0,68
9-8	-	0,68	-	-	-	-
10-6	-	0,64	-	0,81	1,84	1,27
10-8	0,78	0,62	0,92	0,81	2,53	0,91
12-8	-	0,71	1,38	0,87	-	1,27
12-10	0,83	0,68	1,06	0,87	-	1,14
14-12	-	2,28	-	2,75	-	-
16-12	-	2,53	-	3,30	-	-

	EPY "Y"	EPE "T"	EPV Dirsek	EPU Düz Nipel	EPM Perde Geçiş Nipeli	EPZA Kruva	EPP Tapa	EPK Çoklu Dağıtıcı	EHVFF Küresel Vana	EPA Hız Ayar Valfi
Ölçü - Ø mm										
4	0,50	0,51	0,37	0,34	0,97	0,67	0,29	1,34	3,75	2,00
6	0,53	0,56	0,38	0,36	1,16	0,81	0,37	1,34	3,75	2,37
8	0,55	0,58	0,43	0,42	1,35	1,02	0,42	1,34	4,10	2,55
10	0,85	0,74	0,49	0,47	2,06	1,02	0,54	-	5,52	3,96
12	0,96	0,86	0,58	0,65	2,00	1,27	0,68	-	6,14	5,94
14	2,77	3,24	3,00	1,82	4,14	-	-	-	-	-
16	3,40	2,40	3,15	1,98	4,41	-	-	-	-	-

SUSTURUCULAR				
	A Sinter Bronz Uzun	V Sinter Bronz Kısa	SD Sinter Bronz Kısmalı	SU Plastik
Ölçü - Ø mm				
M5	0,33	0,30	-	-
1/8"	0,34	0,26	0,98	0,30
1/4"	0,58	0,44	1,34	0,45
3/8"	0,96	0,62	2,15	0,63
1/2"	1,38	0,88	4,03	0,79
3/4"	3,10	1,66	8,63	4,07
1"	5,30	3,30	17,14	4,41
1 1/4"	21,60	-	-	-
1 1/2"	30,00	-	-	-
2"	40,80	-	-	-

Bağlantı Elemanları - Plastik, Metrik Dişli

EPC Düz Rakor		
		
MODEL	ÖLÇÜ	USD Fiyat
EPC06-12	06-M12*1,5	0,59
EPC06-14	06-M14*1,5	0,59
EPC06-16	06-M16*1,5	0,59
EPC06-18	06-M18*1,5	0,80
EPC06-22	06-M22*1,5	1,40
EPC08-12	08-M12*1,5	0,60
EPC08-14	08-M14*1,5	0,60
EPC08-16	08-M16*1,5	0,78
EPC08-18	08-M18*1,5	1,50
EPC08-22	08-M22*1,5	1,50
EPC10-12	10-M12*1,5	0,86
EPC10-14	10-M14*1,5	0,85
EPC10-16	10-M16*1,5	0,88
EPC10-18	10-M18*1,5	1,00
EPC10-22	10-M22*1,5	1,40
EPC12-12	12-M12*1,5	1,20
EPC12-14	12-M14*1,5	1,40
EPC12-16	12-M16*1,5	1,54
EPC12-18	12-M18*1,5	1,50
EPC12-22	12-M22*1,5	1,80

EPL Döner Dirsek		
		
MODEL	ÖLÇÜ	USD Fiyat
EPL06-12	06-M12*1,5	0,88
EPL06-14	06-M14*1,5	0,81
EPL06-16	06-M16*1,5	0,84
EPL06-18	06-M18*1,5	1,87
EPL06-22	06-M22*1,5	1,98
EPL08-12	08-M12*1,5	0,79
EPL08-14	08-M14*1,5	0,88
EPL08-16	08-M16*1,5	0,98
EPL08-18	08-M18*1,5	1,93
EPL08-22	08-M22*1,5	1,95
EPL10-12	10-M12*1,5	1,38
EPL10-14	10-M14*1,5	1,40
EPL10-16	10-M16*1,5	1,27
EPL10-18	10-M18*1,5	1,98
EPL10-22	10-M22*1,5	2,50
EPL12-12	12-M12*1,5	1,53
EPL12-14	12-M14*1,5	1,60
EPL12-16	12-M16*1,5	1,93
EPL12-18	12-M18*1,5	2,08
EPL12-22	12-M22*1,5	1,80

EPU Düz Nipel		
		
MODEL	ÖLÇÜ	USD Fiyat
EPU05	5 mm	0,46
EPU07	7 mm	0,46
EPU09	9 mm	0,64
EPU11	11 mm	0,78
EPU15	15 mm	2,30
EPU3/8	9,52 mm	0,92
EPU1/2	12,7 mm	1,15

EPE "T"		
		
MODEL	ÖLÇÜ	USD Fiyat
EPE07	7 mm	0,58
EPE09	9 mm	1,02
EPE15	15 mm	2,28





Bağlantı Elemanları - Metal

	EMPC Düz Rakor	EMPL Döner Dirsek	EMPCF Dişi Rakor	EMPB Orta Bacak "T"	EMPD Yan Bacak "T"	EMPSC Hız Ayarlı Döner Dirsek
Ölçü						
04-M5	0,78	1,64	1,50	2,31	2,31	2,44
04-1/8"	0,98	1,68	1,50	2,42	2,42	4,73
04-1/4"	1,20	-	1,50	2,63	2,63	6,30
04-3/8"	1,68	3,15	1,67	3,89	3,89	6,93
04-1/2"	1,80	3,15	1,96	4,52	-	7,35
06-M5	1,08	2,15	1,50	2,92	2,92	2,89
06-1/8"	1,02	2,15	1,55	3,68	2,98	4,27
06-1/4"	1,13	2,33	1,67	3,78	3,06	6,30
06-3/8"	1,69	2,99	1,96	3,99	3,99	6,58
06-1/2"	1,92	3,26	2,30	4,73	4,73	8,93
08-1/8"	1,15	2,64	1,55	4,52	3,64	4,27
08-1/4"	1,37	2,73	1,73	4,73	3,71	6,30
08-3/8"	1,69	3,26	2,01	5,04	3,85	7,14
08-1/2"	2,38	3,36	2,13	5,25	4,47	7,88
10-1/8"	1,80	3,27	1,90	4,39	4,39	4,73
10-1/4"	1,83	-	1,96	4,52	4,45	6,01
10-3/8"	1,96	3,94	2,01	4,73	4,60	7,35
10-1/2"	2,24	4,20	3,34	5,25	4,95	8,19
12-1/4"	2,16	4,10	2,51	6,30	5,21	6,83
12-3/8"	2,34	4,41	3,22	6,51	5,34	7,35
12-1/2"	3,30	4,73	3,45	6,83	5,69	8,40
14-3/8"	4,80	7,88	-	-	-	-
14-1/2"	5,40	7,88	-	-	-	-
16-3/8"	5,40	8,93	-	-	-	-
16-1/2"	5,16	8,93	-	-	-	-





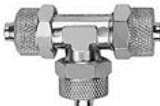



	EMPU Düz Nipel	EMPV Dirsek	EMPE "T"	EMPY "Y"	EMPM Perde Geçiş Nipel
Ölçü - Ø mm					
4	1,25	1,26	2,21	2,63	2,63
6	1,37	1,47	2,21	2,63	2,73
8	1,84	1,89	3,43	3,40	3,47
10	2,50	2,52	4,94	5,78	4,20
12	2,98	3,15	5,67	7,35	4,94
14	4,73	5,46	-	-	-
16	5,78	6,09	-	-	-

Bağlantı Elemanları - Somun Sıkmalı

	RPC Düz Rakor	RPL Döner Dirsek	RPT Orta Bacak "T"	RPD Yan Bacak "T"	MNSR Hız Ayarlı Döner Dirsek
Ölçü					
4/2-1/8"	0,74	1,71	-	-	-
6/4-M5	0,67	1,13	-	-	-
6/4-1/8"	0,76	1,13	1,69	2,05	4,64
6/4-1/4"	0,93	1,65	1,89	2,14	4,64
6/4-3/8"	1,17	1,99	2,76	2,36	6,79
6/4-1/2"	1,94	2,49	-	-	7,79
8/6-1/8"	0,99	1,29	2,40	2,19	4,45
8/6-1/4"	1,17	1,65	3,16	2,25	4,78
8/6-3/8"	1,51	2,00	3,60	2,54	5,61
8/6-1/2"	2,22	2,49	4,32	4,18	7,42
10/8-1/8"	1,23	1,73	-	-	-
10/8-1/4"	1,35	1,73	-	-	-
10/8-3/8"	1,57	2,05	-	-	-
10/8-1/2"	2,51	2,74	-	-	-
12/10-1/4"	2,06	2,89	-	-	-
12/10-3/8"	2,15	2,97	-	-	-
12/10-1/2"	2,88	3,49	-	-	-

	RPUC Düz Nipel	RPUL Dirsek	RPUT "T"	RPZA Kruva
Ölçü - Ø mm				
4/2	1,08	-	1,89	-
6/4	1,13	1,50	1,89	2,70
8/6	1,57	1,90	2,61	4,26
10/8	2,19	-	2,79	-
12/9	2,42	-	-	-
12/10	3,07	-	4,72	-

Hava Tabancaları

Tanımı	Foto	Model	Adet Fiyatı (\$)
Plastik Hava Tabancası Renk Seçenekleri:   		EB-094	1,92
Plastik Hava Tabancası Uzun Tip (30cm)		A300	2,80
Metal Hava Tabancası (Jaklı)		EB-092	4,79
Metal Hava Tabancası (1/4" BSP)		EB-092A	4,91
Metal Hava Tabancası (Jaklı, Uzun)		EB-093	4,91
Metal Hava Tabancası Uzun Tip (1/4" BSP - 30cm)		DG-10B-3	6,44

Hortum Makası

	KOD	TANIM	USD FİYAT
	TC-B	HORTUM MAKASI	2,00

PNÖMATİK

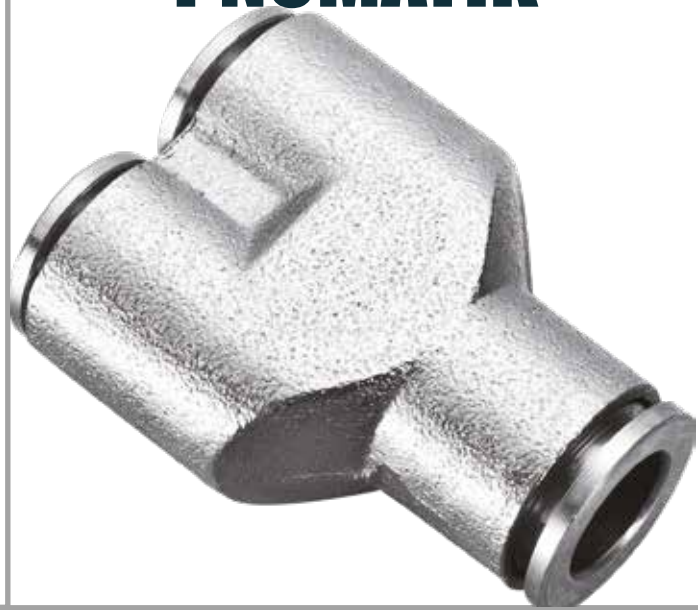

FIRETECH



Pnömomatik

İçerik:

☐ Pnömatik Hortumlar

»83-85



Hortumlar

Kimyasal Dayanım Cetveli

Chemical Resistance Table

	PA	PE	PVC	PUR		PA	PE	PVC	PUR
	Polyamide	Polyethylene	Polyvinyl chloride soft	Polyurethane		Polyamide	Polyethylene	Polyvinyl chloride soft	Polyurethane
1 Acetic acid	4	2	3	3	100 Lemon juice	1	1	1	1
2 Acetic acid anhydride	1	3	4	4	101 Linseed oil	1	1	3	1
3 Acetone	1	1	5	4	102 Liquors	1	1	2	1
4 Aluminium salts, aq	1	4	1	2	103 Magnesium salts, aq	1	1	1	1
5 Alums, aq	1	1	1	1	104 Margarine	1	3	1	1
6 Aminobenzoic acid	2	1	3	4	105 Mercury	1	1	3	1
7 Ammonia, aq	1	1	1	4	106 Mercury salts, aq	1	1	3	1
8 Ammonia, g	1	1	1	1	107 Methanol	1	1	3	2
9 Ammonium acetate, aq	1	1	1	4	108 Methyl ethyl ketone	1	4	3	4
10 Ammonium carbonate, aq	1	1	1	4	109 Methylene chloride	3	4	4	4
11 Ammonium chloride, aq	1	1	1	1	110 Milk	1	1	1	1
12 Ammonium nitrate, aq	1	1	1	1	111 Mustard	1	1	1	1
13 Ammonium phosphate, aq	1	1	1	1	112 Nail varnish	1	1	4	4
14 Ammonium sulfate, aq	1	1	1	1	113 Nail varnish remover	1	1	4	4
15 Amyl alcohol	1	1	1	2	114 Naphthalin	1	4	2	1
16 Antifreeze	1	1	1	2	115 Nickel salts, aq	1	1	1	1
17 Barium salts	1	1	1	1	116 Nitric acid (up to 25 %)	4	2	1	5
18 Battery acid	3	1	3	1	117 Nitrobenzoic acid	2	4	4	4
19 Beef tallow	3	1	2	1	118 Octane	1	1	4	1
20 Beer	1	1	1	1	119 Oil no. 3 (ASTM D390-59)	1	3	2	1
21 Benzaldehyde	1	1	3	3	120 Oleic acid	2	2	2	1
22 Benzoic acid	1	1	3	4	121 Olive oil	1	1	2	1
23 Benzoic acid, aq	1	1	1	4	122 Oxalic acid, aq	2	1	3	4
24 Bone fat	1	2	3	1	123 Ozone (<0.5 ppm)	1	4	3	1
25 Boric acid	1	1	1	1	124 Palm oil	1	4	3	2
26 Brake fluid	1	3	3	4	125 Paraffin	1	3	1	2
27 Bromine, aq	4	4	4	4	126 Paraffin ether	1	4	3	1
28 Bromine, l	4	4	4	4	127 Paraffin oil	1	3	1	2
29 Butane, g	1	4	1	1	128 Paraffin oil (petroleum jelly)	1	3	2	2
30 Butane, l	1	1	2	1	129 Pectin	1	1	1	1
31 n-Butanol	1	4	3	4	130 Pepper	1	1	1	1
32 n-Butyl alcohol	1	4	4	4	131 Peppermint oil	1	3	2	1
33 Butylacetate (acetic acid butyl ester)	4	4	5	4	132 Perfume	4	1	4	1
34 Butylacetate	1	2	4	4	133 Phenol	4	4	4	4
35 Calcium chloride, aq	1	1	1	1	134 Phosphoric acid	4	4	1	3
36 Calcium nitrate, aq	1	1	1	1	135 Phosphorus pentoxide	3	1	1	2
37 Carbon disulfide	1	4	4	3	136 Pine needle oil	1	2	2	2
38 Carbon tetrachloride	1	4	4	3	137 Potassium carbonate	1	1	1	3
39 Carnation oil	1	4	2	1	138 Potassium chlorate, aq	2	1	1	2
40 Chlorine, g	4	4	4	4	139 Potassium chloride, aq	1	1	1	1
41 Chlorine, l	4	4	4	4	140 Potassium chromate, aq	3	1	1	1
42 Chlorobenzoic acid	3	4	4	3	141 Potassium hydroxide, aq	1	1	2	1
43 Chloroform	3	4	4	4	142 Potassium iodine, aq	1	1	1	2
44 Chlorosulfonic acid	4	4	4	4	143 Potassium nitrate, aq	1	1	1	2
45 Chrome bath	4	1	1	3	144 Potassium permanganate, aq	3	1	1	3
46 Chromic acid	4	2	3	4	145 Potassium sulfate	1	1	1	1
47 Chromosulfuric acid	4	1	2	3	146 Propane, g	1	3	1	2
48 Chromium salts	4	1	1	3	147 Propane, l	1	4	1	2
49 Citric acid	1	1	1	2	148 Pyridine	1	1	4	5
50 Cleaner	1	1	1	1	149 Rum	1	1	2	1
51 Coca-Cola	1	1	1	1	150 Sea water	1	1	1	1
52 Cocua	1	1	1	1	151 Shampoo	1	1	1	1
53 Coconut oil	1	2	1	1	152 Silicon oil	1	1	4	1
54 Cod-liver	1	1	4	1	153 Silver salts, aq	1	1	1	1
55 Coffee	1	1	1	1	154 Soapy water	1	1	1	2
56 Cooking oil, animal	1	3	2	2	155 Soda	1	1	1	1
57 Cooking oil, vegetable	1	4	2	2	156 Sodium bicarbonate, aq	1	1	1	1
58 Corn oil	1	4	1	2	157 Sodium bisulfite, aq	1	1	1	2
59 Cresol	4	4	4	4	158 Sodium carbonate (borax), aq	1	1	1	1
60 Cresol, aq	3	4	4	4	159 Sodium carbonate, aq	1	1	1	1
61 Cyclohexane	1	1	1	2	160 Sodium chlorate	2	1	1	2
62 Cyclohexanol	1	1	5	4	161 Sodium chloride, aq	1	1	1	1
63 Cyclohexanone	1	4	5	1	162 Sodium hydroxide (caustic soda)	1	4	4	4
64 Decalin	1	1	1	2	163 Sodium hydroxide, aq	1	1	1	2
65 Detergent	1	1	2	1	164 Sodium hypochlorite	3	1	3	4
66 Dibutyl phtalate	1	3	3	3	165 Sodium nitrate, aq	1	1	1	1
67 Diesel fuel	1	2	2	1	166 sodium nitrite, aq	2	1	1	1
68 Dimenthylether	1	2	2	2	167 Sodium perborate, aq	1	1	3	2
69 Dimethylformamide	1	1	4	4	168 Sodium phosphate, aq	1	1	1	2
70 1,4-Dicxane	1	1	4	4	169 Sodium silicate	1	1	1	3
71 Engine oil	1	3	3	2	170 Sodium sulfate, aq	1	1	1	1
72 Ethanol	1	1	3	1	171 Sodium sulfide, aq	1	1	1	1
73 Ether	1	4	3	3	172 Sodium sulfite, aq	1	1	1	1
74 Ethyl acetate	1	2	5	4	173 Sodium thiosulfate	1	1	1	2
75 Ethylene chloride	3	4	4	2	174 Sodium thiosulfate (antichlor),aq	1	1	1	2
76 Ethylhexanol	1	4	4	4	175 Soybean oil	1	4	2	2
77 Ferric salts	1	1	1	2	176 Spruce needle oil	1	2	3	2
78 Fizzy drink	1	1	1	1	177 Starch	1	1	1	1
79 Formaldehyde, aq	3	1	3	2	178 Stearic acid	2	4	1	1
80 Formaline	3	1	2	2	179 Sugar, aq	1	1	1	1
81 Formic acid	4	2	4	4	180 Sulfur	1	4	4	1
82 Fruit juice	1	1	1	1	181 Sulfuric acid (concentrated)	4	4	4	4
83 Fuel	1	4	4	2	182 Sulfuric acid (up to 50 %)	4	1	3	2
84 Fuel oil	1	3	4	1	183 Sulfur dioxide, g	1	1	2	3
85 Gin	1	1	2	1	184 Tar (hot tar)	1	3	3	4
86 Glycerine	1	1	1	1	185 Tartaric acid, aq	1	1	1	1
87 Glycol	1	1	1	2	186 Tea	1	1	1	1
88 Heptane	1	1	1	2	187 Tetrahydrofuran	1	3	4	4
89 Hexane	1	1	1	2	188 Tetralin (tetrahydronaphthalene)	1	4	1	2
90 Honey	1	1	1	1	189 Tin dichloride	1	1	1	1
91 Hydrochloric acid (up to 20 %)	4	1	2	2	190 Toluene	1	4	4	4
92 Hydrokloride, g	4	1	2	2	191 Trichloroethylene	2	4	4	4
93 Hydrogen preoxide, aq	2	1	3	2	192 Turpentine (oil of)	1	3	3	4
94 Ink	1	1	1	1	193 Urea, aq	1	1	1	1
95 Isooctane	1	4	1	1	194 Vanilla	1	1	1	1
96 Isoprapanol	1	1	3	3	195 Vaseline	1	3	2	1
97 Jelly	1	1	1	1	196 White spirit	1	4	3	1
98 Lactic acid	2	2	3	3	197 Wine	1	1	1	1
99 Lanolin	1	3	2	1	198 Xylene	1	4	4	4

1 Dayanıklı
Resistant

2 Genellikle dayanıklı
Resistant in general

3 Az dayanıklı
Fairly resistant

4 Dayanısız
Non-resistant

5 Erimeye maruz kalır
Liable to dissolve

Bu tablolar oda şartlarındaki testler ,hammadde tedarikçilerinin tavsiyeleri ve müşterilerimizin tecrübeleriyle hazırlanmıştır. Kullanıcıların farklı şartlardaki uygulamaları ürünlerin verimliliğinde değişik sonuçlar ortaya çıkarabilir. Verilen sonuçlar yaklaşıkktir.

This table has been compiled on the basis of in-house tests,the recommendations of our raw material suppliers and customer experiences.Difference in user environments will affect the performance characteristics of the product in different ways. The ratings given above are therefore approximate only.

PNÖMATİK HORTUMLAR

Gapex Polyamid 12 Hortumlar



ÇAP (Dış x İç)	Ürün Grubu	RENK SEÇENEKLERİ	Fiyat (EUR/m)
3 x 1.5	Polyamid 12 Hortum	● ○	0,182 €
4 x 2	Polyamid 12 Hortum	●	0,257 €
4 x 2.5	Polyamid 12 Hortum	● ○	0,220 €
5 x 3.3	Polyamid 12 Hortum	●	0,297 €
6 x 3	Polyamid 12 Hortum	●	0,536 €
6 x 4	Polyamid 12 Hortum	● ○ ● ● ● ●	0,399 €
7 x 5	Polyamid 12 Hortum	●	0,488 €
7.5 x 3.5	Polyamid 12 Hortum	●	0,875 €
8 x 4.4	Polyamid 12 Hortum	●	0,875 €
8 x 5.5	Polyamid 12 Hortum	●	0,662 €
8 x 6	Polyamid 12 Hortum	● ○ ● ● ● ●	0,544 €
9 x 6	Polyamid 12 Hortum	●	0,887 €
9.5 x 6	Polyamid 12 Hortum	●	1,076 €
9.5 x 7	Polyamid 12 Hortum	●	0,816 €
10 x 7.5	Polyamid 12 Hortum	●	0,863 €
10 x 8	Polyamid 12 Hortum	● ○ ●	0,721 €
11 x 8	Polyamid 12 Hortum	●	1,116 €
11 x 9	Polyamid 12 Hortum	●	0,816 €
12 x 9	Polyamid 12 Hortum	● ○ ● ● ● ●	1,242 €
12.7 x 9	Polyamid 12 Hortum	●	1,573 €
12 x 10	Polyamid 12 Hortum	● ○	0,875 €
12.5 x 10	Polyamid 12 Hortum	● ○	1,101 €
14 x 10	Polyamid 12 Hortum	●	1,880 €
14 x 11	Polyamid 12 Hortum	●	1,458 €
15 x 12	Polyamid 12 Hortum	●	1,608 €
16 x 12	Polyamid 12 Hortum	●	2,188 €
18 x 14	Polyamid 12 Hortum	●	2,531 €
20x16	Polyamid 12 Hortum	●	2,801 €
22x18	Polyamid 12 Hortum	●	3,094 €

Zelfex Polyamid (HIPL) Hortumlar

ÇAP (Dış x İç)	Ürün Gurubu	Fiyat (EUR/m)
6 x 4 mm	Polyamid HIPL Hortum	0,272 €
8 x 5.5 mm	Polyamid HIPL Hortum	0,454 €
8 x 6 mm	Polyamid HIPL Hortum	0,372 €
10 x 7.5 mm	Polyamid HIPL Hortum	0,582 €
10 x 8 mm	Polyamid HIPL Hortum	0,484 €
12 x 9 mm	Polyamid HIPL Hortum	0,830 €
15 x 12 mm	Polyamid HIPL Hortum	1,079 €
16 x 12 mm	Polyamid HIPL Hortum	1,481 €



Gapex Polietilen Hortumlar

ÇAP (Dış x İç)	RENK SEÇENEKLERİ	Fiyat (USD/m)
2 x 4	○ ●	0.113 \$
3 x 5	● ○ ●	0.135 \$
4 x 6	● ○ ● ● ● ●	0.140 \$
4 x 8	●	0.314 \$
5 x 8	● ●	0.236 \$
6 x 8	● ○ ● ● ● ●	0.199 \$
6 x 10	● ○ ●	0.388 \$
6.5 x 10	● ●	0.364 \$
8 x 10	● ○ ●	0.263 \$
8 x 12	● ●	0.469 \$
9 x 11	○ ● ●	0.295 \$
9 x 12	○ ●	0.431 \$
9 x 13	●	0.544 \$
10 x 12	○ ●	0.328 \$
10 x 14	●	0.627 \$
10 x 16	● ●	0.895 \$
12 x 16	● ● ●	0.675 \$



PNÖMATİK HORTUMLAR

PURFLEX (eko)Poliüretan (TPU) Hortumlar (ESTER)

ÇAP (Dış x İç)	RENK SEÇENEKLERİ	Fiyat (USD/m)
2 x 4	○ ●	0.172 \$
4 x 6	○ ● ● ●	0.266 \$
5 x 8	○ ● ● ●	0.471 \$
5.5 x 8	○ ● ● ●	0.410 \$
6 x 8	○ ● ● ●	0.379 \$
6.5 x 10	○ ● ● ●	0.662 \$
7 x 10	○ ●	0.587 \$
8 x 10	○ ●	0.455 \$
8 x 12	○ ● ● ●	0.905 \$
9 x 12	○ ●	0.731 \$
10 x 14	○ ●	1.112 \$
12 x 16	○ ●	1.308 \$



FIRETECH



BORU BAĞ

İçerik:

■ Hidrolik Boru Bağlantı

»88-103



LANTILARI



BORU BAĞLANTILARI

METRİK SOMUN



Seri	Boru Çapı(mm)	Kod	Ürün Adı	Diş Ölçüsü	TL/Ad	Kutu/Ad
L Tipi	6	102220612	S6NB	M12x1,5	1,08	100
	8	102220814	S8NB	M14x1,5	1,33	100
	10	102221016	S10NB	M16x1,5	1,54	100
	12	102221218	S12NB	M18x1,5	1,94	100
	15	102221522	S15NB	M22x1,5	3,28	50
	18	102221826	S18NB	M26x1,5	12,50	50
	22	102222230	S22NB	M30x2	6,38	25
	28	102222836	S28NB	M36x2	27,26	25
	35	102223545	S35NB	M45x2	43,05	10
	42	102224252	S42NB	M52x2	59,14	10
S Tipi	6	102320614	S6YB	M14x1,5	1,38	100
	8	102320816	S8YB	M16x1,5	1,60	100
	10	102321018	S10YB	M18x1,5	2,09	100
	12	102321220	S12YB	M20x1,5	2,34	100
	14	102321422	S14YB	M22x1,5	10,45	50
	16	102321624	S16YB	M24x1,5	4,34	50
	20	102322030	S20YB	M30x2	7,44	25
	25	102322536	S25YB	M36x2	39,15	25
	30	102323042	S30YB	M42x2	47,15	10
	38	102323852	S38YB	M52x2	72,95	10

HORTUM SOMUN

Seri	Boru Çapı(mm)	Kod	Ürün Adı	M	TL/Ad	Kutu/Ad
L Tipi	6	107220612	HS06NB	M12x1,5	1,16	100
	8		HS08NB	M14x1,5	1,43	100
	10	107221016	HS10NB	M16x1,5	1,66	100
	12	107221218	HS12NB	M18x1,5	2,09	100
	15	107221522	HS15NB	M22x1,5	3,54	50
S Tipi	16	107321624	HS16YB	M24x1,5	4,69	50

24° METRİK DÜZ NİPEL



Seri	Boru Çapı(mm)	Kod	Ürün Adı	Diş Ölçüsü	TL/Ad	Kutu/Ad
L Tipi	6	X121200606	XN6NB	M12x1,5	5,15	100
	8	X121200808	XN8NB	M14x1,5	5,83	100
	10	X121201010	XN10NB	M16x1,5	4,69	100
	12	X121201212	XN12NB	M18x1,5	5,83	100
	15	X121201515	XN15NB	M22x1,5	8,20	50
	18	X121201818	XN18NB	M26x1,5	9,90	50
	22	X121202222	XN22NB	M30x2	14,28	25
	28	X121202828	XN28NB	M36x2	22,45	25
	35	X121203535	XN35NB	M45x2	36,38	10
	42	X121204242	XN42NB	M52x2	73,61	10
S Tipi	6	X121300606	XN6YB	M14x1,5	16,30	100
	8	X121300808	XN8YB	M16x1,5	17,35	100
	10	X121301010	XN10YB	M18x1,5	20,15	100
	12	X121301212	XN12YB	M20x1,5	7,75	100
	14	X121301414	XN14YB	M22x1,5	25,73	50
	16	X121301616	XN16YB	M24x1,5	11,69	50
	20	X121302020	XN20YB	M30x2	17,57	25
	25	X121302525	XN25YB	M36x2	30,32	25
	30	X121303030	XN30YB	M42x2	43,54	10
	38	X121303838	XN38YB	M52x2	91,24	10

METRİK 24° DİRSEK



Seri	Boru Çapı(mm)	Kod	Ürün Adı	Diş Ölçüsü	TL/Ad	Kutu/Ad
L Tipi	6	X122200606	XD6NB	M12x1,5	9,73	100
	8	X122200808	XD8NB	M14x1,5	11,56	100
	10	X122201010	XD10NB	M16x1,5	13,07	100
	12	X122201212	XD12NB	M18x1,5	14,36	100
	15	X122201515	XD15NB	M22x1,5	21,67	50
	18	X122201818	XD18NB	M26x1,5	44,80	50
	22	X122202222	XD22NB	M30x2	34,02	25
	28	X122202828	XD28NB	M36x2	60,80	25
	35	X122203535	XD35NB	M45x2	104,89	10
	42	X122204242	XD42NB	M52x2	162,97	10
S Tipi	6	X122300606	XD6YB	M14x1,5	20,62	100
	8	X122300808	XD8YB	M16x1,5	22,25	100
	10	X122301010	XD10YB	M18x1,5	25,68	100
	12	X122301212	XD12YB	M20x1,5	23,41	100
	14	X122301414	XD14YB	M22x1,5	34,93	50
	16	X122301616	XD16YB	M24x1,5	25,27	50
	20	X122302020	XD20YB	M30x2	34,02	25
	25	X122302525	XD25YB	M36x2	56,29	25
	30	X122303030	XD30YB	M42x2	84,55	10
	38	X122303838	XD38YB	M52x2	162,97	10

BORU BAĞLANTILARI

METRİK 24° TEE



Seri	Boru Çapı(mm)	Kod	Ürün Adı	Diş Ölçüsü	TL/Ad	Kutu/Ad
L Tipi	6	X123200606	XT6NB	M12x1,5	11,54	100
	8	X123200808	XT8NB	M14x1,5	13,09	100
	10	X123201010	XT10NB	M16x1,5	15,61	100
	12	X123201212	XT12NB	M18x1,5	17,25	100
	15	X123201515	XT15NB	M22x1,5	25,21	50
	18	X123201818	XT18NB	M26x1,5	65,19	50
	22	X123202222	XT22NB	M30x2	43,63	25
	28	X123202828	XT28NB	M36x2	82,17	25
	35	X123203535	XT35NB	M45x2	160,9	10
42	X123204242	XT42NB	M52x2	235,15	10	
S Tipi	6	X123300606	XT6YB	M14x1,5	29,39	100
	8	X123300808	XT8YB	M16x1,5	32,12	100
	10	X123301010	XT10YB	M18x1,5	41,05	100
	12	X123301212	XT12YB	M20x1,5	26,92	100
	14	X123301414	XT14YB	M22x1,5	53,23	50
	16	X123301616	XT16YB	M24x1,5	31,64	50
	20	X123302020	XT20YB	M30x2	43,63	25
	25	X123302525	XT25YB	M36x2	76,09	25
	30	X123303030	XT30YB	M42x2	116,96	10
38	X123303838	XT38YB	M52x2	235,15	10	

YÜKSÜK



Seri	Boru Çapı(mm)	Kod	Ürün Adı	TL/Ad
L/S Tipi	6	101200600	Y6NB/YB	1,21
	8	101200800	Y8NB/YB	1,27
	10	101201000	Y10NB/YB	1,82
	12	101201200	Y12NB/YB	1,98
L Tipi	15	101201500	Y15NB	2,52
	18	101201800	Y18NB	3,50
	22	101202200	Y22NB	5,05
	28	101202800	Y28NB	7,36
	35	101203500	Y35NB	12,94
	42	101204200	Y42NB	16,97
S Tipi	14	101301400	Y14YB	3,01
	16	101301600	Y16YB	3,23
	20	101302000	Y20YB	5,25
	25	101302500	Y25YB	6,91
	30	101303000	Y30YB	9,78
	38	101303800	Y38YB	14,69

Fiyatlarımız TL cinsindedir.

BSP BLOK-METRİK 24° RAKOR



Seri	Boru Çapı(mm)	Blok Tarafı	Kod	Ürün Adı	TL/Ad	Kutu/Ad	Kutu/Ad
L Tipi	6	G1/8"	X501210602	XRE6NBR02PLX	3,81	100	100
		G1/4"	X501210604	XRE6NBR04PLX	5,83	100	100
	8	G1/8"	X501210802	XRE8NBR02PLX	4,11	100	100
		G1/4"	X501210804	XRE8NBR04PLX	5,75	100	100
		G3/8"	X501210806	XRE8NBR06PLX	7,37	100	50
	10	G1/4"	X501211004	XRE10NBR04PLX	5,91	100	50
		G3/8"	X501211006	XRE10NBR06PLX	7,61	100	25
		G1/2"	X501211008	XRE10NBR08PLX	10,63	50	25
	12	G1/4"	X501211204	XRE12NBR04PLX	6,05	100	10
		G3/8"	X501211206	XRE12NBR06PLX	7,61	100	10
		G1/2"	X501211208	XRE12NBR08PLX	10,63	50	100
	15	G1/2"	X501211508	XRE15NBR08PLX	13,01	50	100
	18	G1/2"	X501211808	XRE18NBR08PLX	11,45	50	100
		G3/4"	X501211812	XRE18NBR12PLX	16,53	25	100
	22	G3/4"	X501212212	XRE22NBR12PLX	17,93	25	50
	28	G1"	X501212816	XRE28NBR16PLX	28,33	25	100
35	G1"	X501213516	XRE35NBR16PLX	41,40	10	50	
	G1 1/4"	X501213520	XRE35NBR20PLX	45,42	10	25	
42	G1 1/4"	X501214220	XRE42NBR20PLX	89,86	10	10	
	G1 1/2"	X501214224	XRE42NBR24PLX	83,15	10	10	
S Tipi	6	G1/4"	X501310604	XRE6YBR04PLX	7,15	100	100
	8	G1/4"	X501310804	XRE8YBR04PLX	7,27	100	100
	10	G1/4"	X501311004	XRE10YBR04PLX	7,27	100	100
		G3/8"	X501311006	XRE10YBR06PLX	8,25	100	100
		G1/2"	X501311008	XRE10YBR08PLX	33,74	50	50
	12	G1/4"	X501311204	XRE12YBR04PLX	8,6	100	50
		G3/8"	X501311206	XRE12YBR06PLX	8,25	100	25
		G1/2"	X501311208	XRE12YBR08PLX	12,09	50	25
	14	G1/2"	X501311408	XRE14YBR08PLX	13,54	50	10
	16	G3/8"	X501311606	XRE16YBR06PLX	11,87	50	10
		G1/2"	X501311608	XRE16YBR08PLX	12,85	50	50
		G3/4"	X501311612	XRE16YBR12PLX	17,34	25	50
	20	G1/2"	X501312008	XRE20YBR08PLX	17,21	25	25
		G3/4"	X501312012	XRE20YBR12PLX	17,93	25	25
		G1"	X501312016	XRE20YBR16PLX	30,26	25	10
	25	G3/4"	X501312512	XRE25YBR12PLX	33,5	25	100
G1"		X501312516	XRE25YBR16PLX	32,40	25	50	
30	G1"	X501313016	XRE30YBR16PLX	39,89	10	100	
	G1 1/4"	X501313020	XRE30YBR20PLX	48,45	10	25	
38	G1 1/4"	X501313820	XRE38YBR20PLX	92,92	10	25	
	G1 1/2"	X501313824	XRE38YBR24PLX	98,38	10	10	

BORU BAĞLANTILARI

PERDE GEÇİŞ NİPELİ



Seri	Boru Çapı(mm)	Kod	Ürün Adı	Diş Ölçüsü	TL/Ad	Kutu/Ad
L Tipi	6	X181200606	XPGN6NB	M12x1,5	27,59	100
	8	X181200808	XPGN8NB	M14x1,5	11,76	100
	10	X181201010	XPGN10NB	M16x1,5	15,34	100
	12	X181201212	XPGN12NB	M18x1,5	17,69	100
	15	X181201515	XPGN15NB	M22x1,5	23,19	50
	18	X181201818	XPGN18NB	M26x1,5	63,28	50
	22	X181202222	XPGN22NB	M30x2	64,57	25
	28	X181202828	XPGN28NB	M36x2	88,89	25
	35	X181203535	XPGN35NB	M45x2	120,25	10
42	X181204242	XPGN42NB	M52x2	163,62	10	
S Tipi	6	X181300606	XPGN6YB	M14x1,5	30,79	100
	8	X181300808	XPGN8YB	M16x1,5	36,35	100
	10	X181301010	XPGN10YB	M18x1,5	39,08	100
	12	X181301212	XPGN12YB	M20x1,5	22,87	100
	14	X181301414	XPGN14YB	M22x1,5	54,27	50
	16	X181301616	XPGN16YB	M24x1,5	31,17	50
	20	X181302020	XPGN20YB	M30x2	49,17	25
	25	X181302525	XPGN25YB	M36x2	107,55	25
	30	X181303030	XPGN30YB	M42x2	126,81	10
38	X181303838	XPGN38YB	M52x2	200,70	10	

PERDE GEÇİŞ DİRSEĞİ



Seri	Boru Çapı(mm)	Kod	Ürün Adı	Diş Ölçüsü	TL/Ad	Kutu/Ad
L Tipi	6	X183200606	XPGD6NB	M12x1,5	36,98	100
	8	X183200808	XPGD8NB	M14x1,5	33,72	100
	10	X183201010	XPGD10NB	M16x1,5	25,41	100
	12	X183201212	XPGD12NB	M18x1,5	25,65	100
	15	X183201515	XPGD15NB	M22x1,5	37,95	50
	18	X183201818	XPGD18NB	M26x1,5	65,88	50
	22	X183202222	XPGD22NB	M30x2	90,99	25
	28	X183202828	XPGD28NB	M36x2	129,39	25
	35	X183203535	XPGD35NB	M45x2	191,58	10
42	X183204242	XPGD42NB	M52x2	264,95	10	
S Tipi	6	X183300606	XPGD6YB	M14x1,5	37,46	100
	8	X183300808	XPGD8YB	M16x1,5	47,07	100
	10	X183301010	XPGD10YB	M18x1,5	47,36	100
	12	X183301212	XPGD12YB	M20x1,5	36,96	100
	14	X183301414	XPGD14YB	M22x1,5	59,49	50
	16	X183301616	XPGD16YB	M24x1,5	39,43	50
	20	X183302020	XPGD20YB	M30x2	64,34	25
	25	X183302525	XPGD25YB	M36x2	129,39	25
	30	X183303030	XPGD30YB	M42x2	187,54	10
38	X183303838	XPGD38YB	M52x2	264,95	10	

BSPT BLOK(KONİK)-METRİK 24° DİRSEK

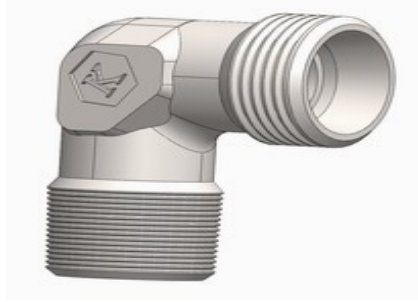

Seri	Boru Çapı(mm)	Blok Tarafı	Kod	Ürün Adı	TL/Ad	Kutu/Ad	Kutu/Ad
L Tipi	6	R1/8"	X161250602	XEDD6NBR02	9,80	100	100
		R1/4"	X161250604	XEDD6NBR04	11,55	100	100
	8	R1/8"	X161250802	XEDD8NBR02	11,56	100	100
		R1/4"	X161250804	XEDD8NBR04	11,95	100	100
		R3/8"	X161250806	XEDD8NBR06	15,00	100	50
	10	R1/4"	X161251004	XEDD10NBR04	13,42	100	50
		R3/8"	X161251006	XEDD10NBR06	15,00	100	25
		R1/2"	X161251008	XEDD10NBR08	27,29	50	25
	12	R1/4"	X161251204	XEDD12NBR04	15,00	100	10
		R3/8"	X161251206	XEDD12NBR06	15,00	100	10
		R1/2"	X161251208	XEDD12NBR08	25,27	50	100
	15	R1/2"	X161251508	XEDD15NBR08	25,27	50	100
	18	R1/2"	X161251808	XEDD18NBR08	49,78	50	100
	22	R3/4"	X161252212	XEDD22NBR12	62,45	25	100
	28	R1"	X161252816	XEDD28NBR16	98,07	25	50
35	R 1 1/4"	X161253520	XEDD35NBR20	128,45	10	100	
42	R 1 1/2"	X161254224	XEDD42NBR24	177,82	10	50	
S Tipi	6	R1/4"	X161350604	XEDD6YBR04	23,39	100	100
	8	R1/4"	X161350804	XEDD8YBR04	25,14	100	100
	10	R3/8"	X161351006	XEDD10YBR06	29,30	100	100
		R3/8"	X161351206	XEDD12YBR06	33,19	100	100
	12	R1/2"	X161351208	XEDD12YBR08	42,69	50	50
		R1/2"	X161351408	XEDD14YBR08	47,43	50	50
	16	R3/8"	X161351606	XEDD16YBR06	25,27	25	25
		R1/2"	X161351608	XEDD16YBR08	25,27	25	25
	20	R1/2"	X161352008	XEDD20YBR08	40,82	10	10
		R3/4"	X161352012	XEDD20YBR12	64,20	10	10
	25	R3/4"	X161352512	XEDD25YBR12	91,66	50	50
		R1"	X161352516	XEDD25YBR16	69,27	50	50
	30	R1"	X161353016	XEDD30YBR16	116,55	25	25
R1 1/4"		X161353020	XEDD30YBR20	128,45	25	25	
38	R1 1/2"	X161353824	XEDD38YBR24	177,82	10	10	

BORU BAĞLANTILARI

BSP BLOK-DÖNER DİRSEK



Seri	Boru Çapı(mm)	Blok Tarafı	Kod	Ürün Adı	TL/Ad	Kutu/Ad
L Tipi	6	G1/8"	X206210602	XDD6NBR02KDS	39,32	100
		G1/4"	X206210604	XDD6NBR04KDS	35,55	100
	8	G1/4"	X206210804	XDD8NBR04KDS	35,55	100
	10	G1/4"	X206211004	XDD10NBR04KDS	35,55	100
	12	G3/8"	X206211206	XDD12NBR06KDS	45,37	100
	15	G1/2"	X206211508	XDD15NBR08KDS	90,47	50
	18	G1/2"	X206211808	XDD18NBR08KDS	90,47	50
	22	G3/4"	X206212212	XDD22NBR12KDS	130,1	25
	28	G1"	X206212816	XDD28NBR16KDS	188,30	25
	35	G1 1/4"	X206213520	XDD35NBR20KDS	282,22	10
42	G1 1/2"	X206214224	XDD42NBR24KDS	347,14	10	
S Tipi	6	G1/4"	X206310604	XDD6YBR04KDS	44,08	100
	8	G1/4"	X206310804	XDD8YBR04KDS	44,08	100
	10	G3/8"	X206311006	XDD10YBR06KDS	55,79	100
	12	G3/8"	X206311206	XDD12YBR06KDS	45,37	100
	14	G1/2"	X206311408	XDD14YBR08KDS	90,47	50
	16	G1/2"	X206311608	XDD16YBR08KDS	73,15	50
	20	G3/4"	X206312012	XDD20YBR12KDS	111,53	25
	25	G1"	X206312516	XDD25YBR16KDS	188,30	25
	30	G1 1/4"	X206313020	XDD30YBR20KDS	282,2	10
	38	G1 1/2"	X206313824	XDD38YBR24KDS	347,14	10

YAN BACAĞI TERS TEE (PİMLİ)

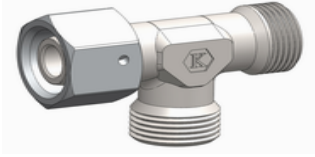

Seri	Boru Çapı(mm)	Kod	Ürün Adı	Diş Ölçüsü	TL/Ad	Kutu/Ad
L tipi	6	X516200606	XYTP6NB12	M12x1,5	22,53	100
	8	X516200808	XYTP8NB14	M14x1,5	22,9	100
	10	X516201010	XYTP10NB16	M16x1,5	26,70	100
	12	X516201212	XYTP12NB18	M18x1,5	22,78	100
	15	X516201515	XYTP15NB22	M22x1,5	33,30	50
	18	X516201818	XYTP18NB26	M26x1,5	91,15	50
	22	X516202222	XYTP22NB30	M30x2	67,45	25
	28	X516202828	XYTP28NB36	M36x2	124,8	25
	35	X516203535	XYTP35NB45	M45x2	228,87	10
S Tipi	42	X516204242	XYTP42NB52	M52x2	327,98	10
	6	X516300606	XYTP6YB14	M14x1,5	37,78	100
	8	X516300808	XYTP8YB16	M16x1,5	69,25	100
	10	X516301010	XYTP10YB18	M18x1,5	47,67	100
	12	X516301212	XYTP12YB20	M20x1,5	34,8	100
	14	X516301414	XYTP14YB22	M22x1,5	73,38	50
	16	X516301616	XYTP16YB24	M24x1,5	41,17	50
	20	X516302020	XYTP20YB30	M30x2	61,86	25
	25	X516302525	XYTP25YB36	M36x2	123,04	25
	30	X516303030	XYTP30YB42	M42x2	207,89	10
38	X516303838	XYTP38YB52	M52x2	340,35	10	

ORTA BACAĞI TERS TEE (PİMLİ)



Seri	Boru Çapı(mm)	Kod	Ürün Adı	Diş Ölçüsü	TL/Ad	Kutu/Ad
L tipi	6	X522220612	XOTP6NB12	M12x1,5	22,53	100
	8	X522220814	XOTP8NB14	M14x1,5	22,90	100
	10	X522221016	XOTP10NB16	M16x1,5	26,70	100
	12	X522221218	XOTP12NB18	M18x1,5	22,78	100
	15	X522221522	XOTP15NB22	M22x1,5	33,30	50
	18	X522221826	XOTP18NB26	M26x1,5	91,15	50
	22	X522222230	XOTP22NB30	M30x2	67,45	25
	28	X522222836	XOTP28NB36	M36x2	124,80	25
	35	X522223545	XOTP35NB45	M45x2	228,87	10
	S Tipi	42	X522224252	XOTP42NB52	M52x2	327,98
6		X522320614	XOTP6YB14	M14x1,5	37,78	100
8		X522320816	XOTP8YB16	M16x1,5	69,25	100
10		X522321018	XOTP10YB18	M18x1,5	47,67	100
12		X522321220	XOTP12YB20	M20x1,5	34,80	100
14		X522321422	XOTP14YB22	M22x1,5	73,38	50
16		X522321624	XOTP16YB24	M24x1,5	41,17	50
20		X522322030	XOTP20YB30	M30x2	61,86	25
25		X522322536	XOTP25YB36	M36x2	123,04	25
30		X522323042	XOTP30YB42	M42x2	207,89	10
38	X522323852	XOTP38YB52	M52x2	340,35	10	

BORU BAĞLANTILARI

TERS DİRSEK PİMLİ



Seri	Boru Çapı(mm)	Kod	Ürün Adı	Diş Ölçüsü	TL/Ad	Kutu/Ad
L tipi	06	X513200606	XTDP6NB	M12x1,5	20,58	100
	08	X513200808	XTDP8NB	M14x1,5	16,30	100
	10	X513201010	XTDP10NB	M16x1,5	19,62	100
	12	X513201212	XTDP12NB	M18x1,5	19,26	100
	15	X513201515	XTDP15NB	M22x1,5	29,47	50
	18	X513201818	XTDP18NB	M26x1,5	68,51	50
	22	X513202222	XTDP22NB	M30x2	50,32	25
	28	X513202828	XTDP28NB	M36x2	90,95	25
	35	X513203535	XTDP35NB	M45x2	149,97	10
	42	X513204242	XTDP42NB	M52x2	223,00	10
S Tipi	06	X513300606	XTDP6YB	M14x1,5	27,69	100
	08	X513300808	XTDP8YB	M16x1,5	29,50	100
	10	X513301010	XTDP10YB	M18x1,5	34,42	100
	12	X513301212	XTDP12YB	M20x1,5	28,69	100
	14	X513301414	XTDP14YB	M22x1,5	64,19	50
	16	X513301616	XTDP16YB	M24x1,5	32,41	50
	20	X513302020	XTDP20YB	M30x2	46,65	25
	25	X513302525	XTDP25YB	M36x2	99,65	25
	30	X513303030	XTDP30YB	M42x2	145,34	10
	38	X513303838	XTDP38YB	M52x2	234,14	10

BSP BLOK - METRİK 24° TERS RAKOR(PİMLİ)



Seri	Boru Çapı(mm)	Blok Tarafı	Kod	Ürün Adı	TL/Ad	Kutu/Ad
L tipi	6	G1/8"	512210602	TREP6NBR02PLX	20,30	100
	8	G1/4"	512210804	TREP8NBR04PLX	12,20	100
	10	G1/4"	512211004	TREP10NBR04PLX	12,97	100
	12	G3/8"	512211206	TREP12NBR06PLX	15,03	100
	15	G1/2"	512211508	TREP15NBR08PLX	42,38	50
	18	G1/2"	512211808	TREP18NBR08PLX	53,91	50
	22	G3/4"	512212212	TREP22NBR12PLX	59,44	25
	28	G1"	512212816	TREP28NBR16PLX	96,23	25
	35	G1 1/4"	512213520	TREP35NBR20PLX	137,08	10
	42	G1 1/2"	512214224	TREP42NBR24PLX	176,58	10
S Tipi	6	G1/4"	512310604	TREP6YBR04PLX	28,02	100
	8	G1/4"	512310804	TREP8YBR04PLX	31,38	100
	10	G3/8"	512311006	TREP10YBR06PLX	33,61	100
	12	G3/8"	512311206	TREP12YBR06PLX	37,24	100
	14	G1/2"	512311408	TREP14YBR08PLX	53,29	50
	16	G1/2"	512311608	TREP16YBR08PLX	23,39	50
	20	G3/4"	512312012	TREP20YBR12PLX	34,27	25
	25	G1"	512312516	TREP25YBR16PLX	78,88	25
	30	G1 1/4"	512313020	TREP30YBR20PLX	146,49	10
	38	G1 1/2"	512313824	TREP38YBR24PLX	202,84	10

BSP REDÜKSİYON



Kod	Ürün Adı	TL/Ad	Kutu/Ad
506010402	RD1/4"-1/8"PLX	5,83	100
506010602	RD3/8"-1/8"PLX	6,88	100
506010604	RD3/8"-1/4"PLX	8,37	50
506010804	RD1/2"-1/4"PLX	8,76	25
506010806	RD1/2"-3/8"PLX	11,65	50
506011204	RD3/4"-1/4"PLX	13,44	25
506011206	RD3/4"-3/8"PLX	12,44	25
506011208	RD3/4"-1/2"PLX	16,38	25
506011604	RD1"-1/4"PLX	33,33	25
506011608	RD1"-1/2"PLX	20,33	25
506011612	RD1"-3/4"PLX	28,11	25
506012012	RD11/4"-3/4"PLX	44,25	10
506012016	RD11/4"-1"PLX	60,59	10
506012416	RD11/2"-1"PLX	70,59	10
506012420	RD11/2"-11/4"PLX	90,12	10

BSP LÜLE - L/PLX

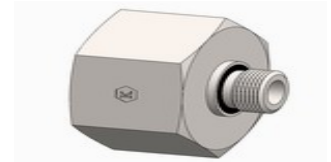

Kod	Ürün Adı	TL/Ad	Kutu/Ad
507010204	L1/8"-1/4"PLX	6,71	100
507010206	L1/8"-3/8"PLX	27,63	100
507010406	L1/4"-3/8"PLX	10,29	100
507010408	L1/4"-1/2"PLX	15,92	50
507010608	L3/8"-1/2"PLX	16,13	50
507010612	L3/8"-3/4"PLX	51,53	25
507010812	L1/2"-3/4"PLX	52,39	25
507010820	L1/2"-11/4"PLX	92,67	10
507011216	L3/4"-1"PLX	54,96	25
507011220	L3/4"-11/4"PLX	94,89	10
507011620	L1"-11/4"PLX	97,28	10
507011624	L1"-11/2"PLX	115,36	10
507012024	L11/4"-11/2"PLX	117,41	10

BORU BAĞLANTILARI

BSP ALLEN BAŞLI KÖR TAPA



Diş Ölçüsü	Kod	Ürün Adı	TL/Ad	Kutu/Ad
G1/8"	510010202	ALKT1/8"PLX	4,19	100
G1/4"	510010404	ALKT1/4"PLX	5,17	100
G3/8"	510010606	ALKT3/8"PLX	5,92	100
G1/2"	510010808	ALKT1/2"PLX	7,79	50
G3/4"	510011212	ALKT3/4"PLX	10,79	25
G1"	510011616	ALKT1"PLX	15,54	25
G1 1/4"	510012020	ALKT11/4"PLX	42,29	10
G1 1/2"	510012424	ALKT11/2"PLX	46,62	10

METRİK ALLEN BAŞLI KÖR TAPA



Diş Ölçüsü	Kod	Ürün Adı	TL/Ad	Kutu/Ad
M10x1	511021010	ALKTM10PLX	8,54	100
M12x1,5	511021212	ALKTM12PLX	9,46	100
M14x1,5	511021414	ALKTM14PLX	9,94	100
M16x1,5	511021616	ALKTM16PLX	10,77	100
M18x1,5	511021818	ALKTM18PLX	11,47	50
M20x1,5	511022020	ALKTM20PLX	14,84	50
M22x1,5	511022222	ALKTM22PLX	15,46	50
M26x1,5	511022626	ALKTM26PLX	18,99	25
M27x2	511022727	ALKTM27PLX	18,99	25
M33x2	511023333	ALKTM33PLX	35,71	25
M42x2	511024242	ALKTM42PLX	46,99	10
M48x2	511024848	ALKTM48PLX	51,80	10

BSP MANŞON



Diş Ölçüsü	Kod	Ürün Adı	TL/Ad	Kutu/Ad
G1/8"	301010202	MA1/8"	3,46	100
G1/4"	301010404	MA1/4"	5,51	100
G3/8"	301010606	MA3/8"	6,81	100
G1/2"	301010808	MA1/2"	9,82	50
G3/4"	301011212	MA3/4"	14,42	50
G1"	301011616	MA1"	36,26	25
G1 1/4"	301012020	MA11/4"	53,74	25
G1 1/2"	301012424	MA11/2"	80,28	10

BSP KÖRTAPA



Diş Ölçüsü	Kod	Ürün Adı	TL/Ad	Kutu/Ad
G1/8"	321010202	KT1/8"	2,64	100
G1/4"	321010404	KT1/4"	4,15	100
G3/8"	321010606	KT3/8"	5,05	100
G1/2"	321010808	KT1/2"	8,13	50
G3/4"	321011212	KT3/4"	11,63	50
G1"	321011616	KT1"	19,15	25
G1 1/4"	321012020	KT11/4"	32,23	25
G1 1/2"	321012424	KT11/2"	68,04	10
G2"	321013232	KT2"	114,4	10

BSP DÜZ NİPEL



Diş Ölçüsü	Kod	Ürün Adı	TL/Ad	Kutu/Ad
G1/8"	302140202	DN30-1/8"	5,59	100
G1/4"	302140404	DN30-1/4"	6,03	100
G3/8"	302140606	DN30-3/8"	7,71	100
G1/2"	302140808	DN30-1/2"	11,82	50
G3/4"	302141212	DN30-3/4"	17,34	50
G1"	302141616	DN30-1"	27,94	25
G1 1/4"	302142020	DN30-11/4"	54,06	25
G1 1/2"	302142424	DN30-11/2"	91,24	10

BSP ORANTILI NİPEL - ODZN



Diş Ölçüsü	Kod	Ürün Adı	TL/Ad	Kutu/Ad
G1/8"-G1/4"	310010402	ODZN1/4"-1/8"	5,83	100
G1/4"-G3/8"	310010604	ODZN3/8"-1/4"	9,09	100
G1/4"-G1/2"	310010804	ODZN1/2"-1/4"	11,32	100
G3/8"-G1/2"	310010806	ODZN1/2"-3/8"	10,9	100
G1/2"-G3/4"	310011208	ODZN3/4"-1/2"	16,45	100
G3/4"-G1"	310011612	ODZN1"-3/4"	27,98	50
G3/4"-G1 1/4"	310012012	ODZN11/4"-3/4"	53,17	25
G3/4"-G1 1/2"	310012412	ODZN11/2"-3/4"	92,12	10
G1"-G1 1/4"	310012016	ODZN11/4"-1"	55,27	25
G1"-G1 1/2"	310012416	ODZN11/2"-1"	95,19	10
G1 1/4"-G1 1/2"	310012420	ODZN11/2"-11/4"	95,19	10

BORU BAĞLANTILARI

BSP DİŐİ DİRSEK



DİŐİ ÖLÇÜŐÜ	Kod	Ürün Adı	TL/Ad	Kutu/Ad
G1/8"	303010202	IDD1/8"	14,36	100
G1/4"	303010404	IDD1/4"	14,67	100
G3/8"	303010606	IDD3/8"	21,4	100
G1/2"	303010808	IDD1/2"	31,04	50
G3/4"	303011212	IDD3/4"	49,46	50
G1"	303011616	IDD1"	83,46	25
G1 1/4"	303012020	IDD11/4"	122,42	25
G1 1/2"	303012424	IDD11/2"	215,47	10

BSP DİŐİ TEE



DİŐİ ÖLÇÜŐÜ	Kod	Ürün Adı	TL/Ad	Kutu/Ad
G1/8"	304010202	IDT1/8"	17,25	100
G1/4"	304010404	IDT1/4"	18,22	100
G3/8"	304010606	IDT3/8"	26,69	100
G1/2"	304010808	IDT1/2"	42,05	50
G3/4"	304011212	IDT3/4"	67,41	50
G1"	304011616	IDT1"	109,84	25
G1 1/4"	304012020	IDT11/4"	179,52	25
G1 1/2"	304012424	IDT11/2"	264,06	10

BSPT KUYRUKLU DİRSEK

DİŐİ ÖLÇÜŐÜ	Kod	Ürün Adı	TL/Ad	Kutu/Ad
G1/8"	307010202	KYD1/8"	27,41	100
G1/4"	307010404	KYD1/4"	34,93	100
G3/8"	307010606	KYD3/8"	40,66	100
G1/2"	307010808	KYD1/2"	36,74	50
G3/4"	307011212	KYD3/4"	82,3	50
G1"	307011616	KYD1"	104,89	25
G1 1/4"	307012020	KYD11/4"	181,08	25



MANOMETRE BAĞLANTI RAKORU

Seri	Boru Çapı(mm)	Blok Tarafı	Kod	Ürün Adı	TL/Ad	Kutu/Ad
L Tipi	6	G1/4"	X263210604	XMBR6NBR04	7,16	100
	8		X263210804	XMBR8NBR04	7,01	100
	10		X263211004	XMBR10NBR04	7,16	100
	12		X263211204	XMBR12NBR04	7,09	100
S Tipi	6	G1/2"	X263310608	XMBR6YBR08	34,71	100
	8		X263310808	XMBR8YBR08	33,89	100
	10		X263311008	XMBR10YBR08	34,71	100
	12		X263311208	XMBR12YBR08	34,71	100

MANOMETRE HALKASI



Seri	Boru Çapı(mm)	Blok Tarafı	Kod	Ürün Adı	TL/Ad	Kutu/Ad
L Tipi	6-8-10-12	1/4"	363210404	MH1/4"	4,75	100
S Tipi	6-8-10-12	1/2"	363310808	MH1/2"	5,54	100

Fiyatlarımız TL cinsindedir.

METRİK 24° KAYNAKLI RAKOR



Seri	Boru Çapı(mm)	Kod	Ürün Adı	Diş Ölçüsü	TL/Ad	Kutu/Ad
L Tipi	6	X281200600	XKRE6NB	M12x1,5	14,14	100
	8	X281200800	XKRE8NB	M14x1,5	17,50	100
	10	X281201000	XKRE10NB	M16x1,5	18,40	100
	12	X281201200	XKRE12NB	M18x1,5	19,42	100
	15	X281201500	XKRE15NB	M22x1,5	24,13	50
	18	X281201800	XKRE18NB	M26x1,5	28,53	50
	22	X281202200	XKRE22NB	M30x2	34,42	25
	28	X281202800	XKRE28NB	M36x2	45,44	25
	35	X281203500	XKRE35NB	M45x2	60,64	10
	42	X281204200	XKRE42NB	M52x2	78,43	10
S Tipi	6	X281300600	XKRE6YB	M14x1,5	19,60	100
	8	X281300800	XKRE8YB	M16x1,5	18,47	100
	10	X281301000	XKRE10YB	M18x1,5	21,22	100
	12	X281301200	XKRE12YB	M20x1,5	22,98	100
	14	X281301400	XKRE14YB	M22x1,5	25,70	50
	16	X281301600	XKRE16YB	M24x1,5	27,80	50
	20	X281302000	XKRE20YB	M30x2	39,99	25
	25	X281302500	XKRE25YB	M36x2	47,49	25
	30	X281303000	XKRE30YB	M42x2	57,68	10
	38	X281303800	XKRE38YB	M52x2	84,92	10

METRİK 24° KAYNAKLI DİRSEK



Seri	Boru Çapı(mm)	Kod	Ürün Adı	Diş Ölçüsü	TL/Ad	Kutu/Ad
L Tipi	6	X282200600	XKD6NB	M12x1,5	22,10	100
	8	X282200800	XKD8NB	M14x1,5	24,36	100
	10	X282201000	XKD10NB	M16x1,5	25,74	100
	12	X282201200	XKD12NB	M18x1,5	14,36	100
	15	X282201500	XKD15NB	M22x1,5	41,08	50
	18	X282201800	XKD18NB	M26x1,5	49,78	50
	22	X282202200	XKD22NB	M30x2	62,47	25
	28	X282202800	XKD28NB	M36x2	91,44	25
	35	X282203500	XKD35NB	M45x2	116,55	10
	42	X282204200	XKD42NB	M52x2	181,08	10
S Tipi	6	X282300600	XKD6YB	M14x1,5	22,10	100
	8	X282300800	XKD8YB	M16x1,5	23,70	100
	10	X282301000	XKD10YB	M18x1,5	29,82	100
	12	X282301200	XKD12YB	M20x1,5	17,20	100
	14	X282301400	XKD14YB	M22x1,5	41,08	50
	16	X282301600	XKD16YB	M24x1,5	20,44	50
	20	X282302000	XKD20YB	M30x2	41,99	25
	25	X282302500	XKD25YB	M36x2	82,30	25
	30	X282303000	XKD30YB	M42x2	116,55	10
	38	X282303800	XKD38YB	M52x2	181,08	10

BORU BAĞLANTILARI

KUYRUKLU YÜKSÜK



Seri	Boru Çapı(mm)	Kod	Ürün Adı	TL/Ad	Kutu/Ad
L/S Tipi	6	508000600	KYO6NB/YB	11,99	100
	8	508000800	KYO8NB/YB	11,36	100
	10	508001000	KYO10NB/YB	11,80	100
	12	508001200	KYO12NB/YB	12,21	100
L Tipi	15	508201500	KYO15NB	16,37	50
	18	508201800	KYO18NB	17,69	50
	22	508202200	KYO22NB	21,84	25
	28	508202800	KYO28NB	29,36	25
	35	508203500	KYO35NB	40,76	10
	42	508204200	KYO42NB	49,20	10
S Tipi	14	508301400	KYO14YB	18,33	50
	16	508301600	KYO16YB	16,03	50
	20	508302000	KYO20YB	20,59	25
	25	508302500	KYO25YB	25,23	25
	30	508303000	KYO30YB	35,68	10
	38	508303800	KYO38YB	50,30	10

KÖRLEME TAPASI O'RINGLI



Seri	Boru Çapı(mm)	Kod	Ürün Adı	TL/Ad	Kutu/Ad
L Tipi	6	X505200600	XTAPO6NB	2,14	100
	8	X505200800	XTAPO8NB	2,37	100
	10	X505201000	XTAPO10NB	2,72	100
	12	X505201200	XTAPO12NB	3,11	100
	15	X505201500	XTAPO15NB	4,25	50
	18	X505201800	XTAPO18NB	14,79	50
	22	X505202200	XTAPO22NB	14,36	25
	28	X505202800	XTAPO28NB	17,81	25
	35	X505203500	XTAPO35NB	31,40	10
	42	X505204200	XTAPO42NB	37,61	10
S Tipi	6	X505200600	XTAPO6YB	2,14	100
	8	X505200800	XTAPO8YB	2,37	100
	10	X505201000	XTAPO10YB	2,72	100
	12	X505201200	XTAPO12YB	3,11	100
	14	X505301400	XTAPO14YB	11,14	50
	16	X505301600	XTAPO16YB	4,79	50
	20	X505302000	XTAPO20YB	7,84	25
	25	X505302500	XTAPO25YB	10,68	25
	30	X505303000	XTAPO30YB	25,14	10
	38	X505303800	XTAPO38YB	36,43	10

FIRETECH

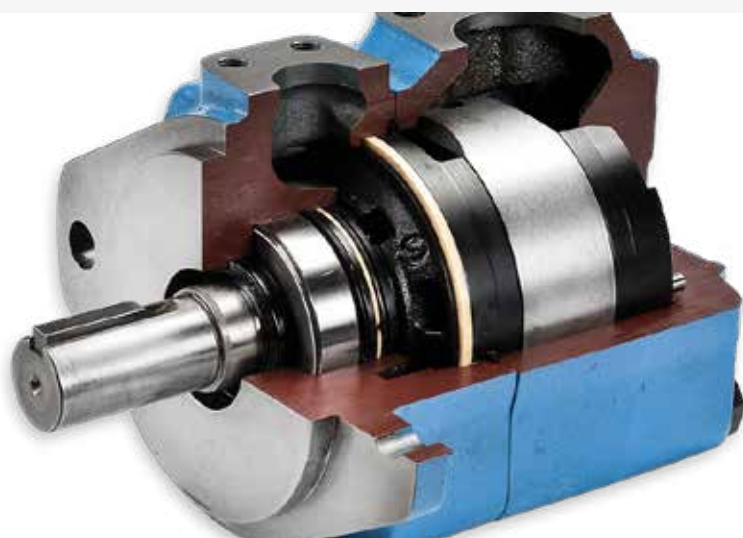

FIRSAT Ü

İçerik:

🔴 Fırsat Ürüleri - Net Fiyat

»106-113



ÜRÜNLERİ

HİDROLİK DİŞLİ POMPALAR

Ürün Kodu	NET FİYAT
0P1 Grubu:	25 USD
1PN Grubu:	29 USD
2P1 Grubu:	67 USD
3P1 Grubu:	105 USD

NET
FİYAT



PALETLİ POMPALAR



STOK CİNSİ	NET FİYAT
V10 SERİSİ	USD 85
V20 SERİSİ	USD 110
20V SERİSİ	USD 155
25V SERİSİ - 10/12/14 galon	USD 195
35V SERİSİ - 45 galon	USD 240
45V SERİSİ	USD 300
KATRIÇ KİTİ V10	USD 37
KATRIÇ KİTİ V20 -8/9/11 galon	USD 50
KATRIÇ KİTİ 20V	USD 90
KATRIÇ KİTİ 35V - 45 galon	USD 135
KATRIÇ KİTİ 45V - 45 galon	USD 160



FIRSAT ÜRÜNLERİ - NET FİYATLAR



HİDROLİK MANİFOLTLAR

STOK CİNSİ	NET FİYAT
M02-03-4B - VALF MANİFOLT A NG6 ALTTAN ÇIKIŞ	10 USD
M02-03-4S - VALF MANİFOLT A NG6 YANDAN ÇIKIŞ	10 USD
M02-03-2S2B - VALF MANİFOLT A NG6 ALT-YAN ÇIKIŞ	10 USD
M02-1E-1 - VALF MANİFOLT NG6 YANDAN ÇIKIŞ 1 AD.	10 USD
M02-8E-1 - VALF MANİFOLT NG6 YANDAN ÇIKIŞ 8 AD.	79 USD
M02-9E-1 - VALF MANİFOLT NG6 YANDAN ÇIKIŞ 9 AD.	89 USD
M02-10E-1 - VALF MANİFOLT NG6 YANDAN ÇIKIŞ 10 AD.	99 USD
M03-04-4B - VALF MANİFOLT A NG10 ALTTAN ÇIKIŞ	20 USD
M03-04-4S - VALF MANİFOLT A NG10 YANDAN ÇIKIŞ	20 USD
M03-04-3S1B - VALF MANİFOLT A NG10 P,A,B YAN ÇIKIŞ-T ALT	20 USD
M03-1E-1 - VALF MANİFOLT NG10 YANDAN ÇIKIŞ 1 AD.	20 USD
M03-2E-1 - VALF MANİFOLT NG10 YANDAN ÇIKIŞ 2 AD.	52 USD
M03-3E-1 - VALF MANİFOLT NG10 YANDAN ÇIKIŞ 3 AD.	74 USD
M03-4E-1 - VALF MANİFOLT NG10 YANDAN ÇIKIŞ 4 AD.	93 USD
M03-5E-1 - VALF MANİFOLT NG10 YANDAN ÇIKIŞ 5 AD.	109 USD
M03-6E-1 - VALF MANİFOLT NG10 YANDAN ÇIKIŞ 6 AD.	124 USD
M03-7E-1 - VALF MANİFOLT NG10 YANDAN ÇIKIŞ 7 AD.	143 USD
M03-8E-1 - VALF MANİFOLT NG10 YANDAN ÇIKIŞ 8 AD.	167 USD
M03-9E-1 - VALF MANİFOLT NG10 YANDAN ÇIKIŞ 9 AD.	197 USD
M03-10E-1 - VALF MANİFOLT NG10 YANDAN ÇIKIŞ 10 AD.	221 USD



FIRSAT ÜRÜNLERİ - NET FİYATLAR

HİDROLİK KUMANDA KOLLARI

STOK CİNSİ	NET FİYAT
MB-3 SERİSİ 45LT TEKLİ 3/8 HİD.KUM.KOLU	25 USD
MB-3 SERİSİ 45LT TEKLİ 1/2 HİD.KUM.KOLU	25 USD
MB-3 SERİSİ 45LT ÜÇLÜ 3/8 HİD.KUM.KOLU	50 USD
MB-3 SERİSİ 45LT ÜÇLÜ 1/2 HİD.KUM.KOLU	50 USD
MB-3 SERİSİ 45LT DÖRTLÜ 1/2 HİD.KUM.KOLU	60 USD
MB-3 SERİSİ 45LT ALTILI 3/8 HİD.KUM.KOLU	90 USD
MB-3 SERİSİ 45LT ALTILI 1/2 HİD.KUM.KOLU	90 USD
MB-5 SERİSİ 80LT TEKLİ 1/2 HİD.KUM.KOLU	35 USD
MB-5 SERİSİ 80LT İKİLİ 1/2 HİD.KUM.KOLU	55 USD
MB-5 SERİSİ 80LT ÜÇLÜ 1/2 HİD.KUM.KOLU	75 USD
MB-5 SERİSİ 80LT BEŞLİ 1/2 HİD.KUM.KOLU	120 USD
MSB-5 SERİSİ 80LT ÜÇLÜ 3/4 HİD.KUM.KOLU	85 USD
MSB-5 SERİSİ 80LT ÜÇLÜ 1 HİD.KUM.KOLU	85 USD
MSB-5 SERİSİ 80LT DÖRTLÜ 1 HİD.KUM.KOLU	110 USD

NET
FİYAT



FIRSAT ÜRÜNLERİ - NET FİYATLAR



PNÖMATİK ŞARTLANDIRICILAR

	STOK CİNSİ		NET FİYAT
EIC2000-01 F+R+L, G1/8"	Gövde: 1/4 Port: 1/8	3'lü şartlandırıcı	5,00 USD
EIC3000-02 F+R+L, G1/4"	Gövde: 3/8 Port: 1/4	3'lü şartlandırıcı	8,00 USD
EIC5000-06 F+R+L, G3/4	Gövde: 3/4 Port: 3/4	3'lü şartlandırıcı	17,50 USD
EIC2010-01 FR+L, G1/8"	Gövde: 1/4 Port: 1/8	2'li şartlandırıcı	5,00 USD
EIC5010-06 FR+L, G3/4	Gövde: 3/4 Port: 3/4	2'li şartlandırıcı	17,50 USD
EIW5000-10 FR, G1	Gövde: 3/4 Port: 1"	Filtre-Regülatör	12,50 USD
EIF3000-02 FİLİTRE, G1/4"	Gövde: 3/8 Port: 1/4	Filtre	2,00 USD
EIL2000-02 YAĞLAYICI, G1/4"	Gövde: 1/4 Port: 1/4	Yağlayıcı	1,50 USD
EIL3000-02 YAĞLAYICI, G1/4"	Gövde: 3/8 Port: 1/4	Yağlayıcı	2,00 USD
EIR5000-10 REGÜLATÖR, G1	Gövde: 3/4 Port: 1"	Regülatör	11,00 USD
EL804-02 YAĞLAYICI, G1/4"	Gövde: 1/4 Port: 1/4	Yağlayıcı	1,50 USD
HNEL2000-02 YAĞLAYICI, G1/4"	Gövde: 1/4 Port: 1/4	Yağlayıcı	1,50 USD
ZDFS-06 OTOMATİK BOŞALTMA ELEMANI 1/8"	1/8"	HAD Tipi Otomatik Boşaltma Elemanı	3,50 USD
ZDFS-08 OTOMATİK BOŞALTMA ELEMANI 1/4"	1/4"	HAD Tipi Otomatik Boşaltma Elemanı	3,50 USD
HAD402 OTOMATİK BOŞALTMALI FİLİTRE	Gövde: 1/2 Port: 1/2	Otomatik Boşaltmalı Filtre	8,00 USD
ZDFS-06 OTOMATİK BOŞALTMA ELEMANI 1/8"	1/8"	HAD Tipi Otomatik Boşaltma Elemanı	3,50 USD
ZDFS-08 OTOMATİK BOŞALTMA ELEMANI 1/4"	1/4"	HAD Tipi Otomatik Boşaltma Elemanı	3,50 USD
HAD402 OTOMATİK BOŞALTMALI FİLİTRE	Gövde: 1/2 Port: 1/2	Otomatik Boşaltmalı Filtre	8,00 USD



SOLENOİD VALFLER



NET
FİYAT

	Ölçü	Tip	"Çalışma Basıncı	NET FİYAT
UD / UDH* SERİSİ KABLOLU SOLENOİD VALF	1/8"	2/2 Direkt	0~7 bar	3,00 USD
	1/4"	2/2 Direkt	0~7 bar	4,00 USD
	3/8"	2/2 Direkt	0~7 bar	6,00 USD
SLG SERİSİ (Y.BAS/Y.SIC.) SOLENOİD VALF (150°C)	1/2"	2/2 Pilot	1~50 bar	15,00 USD
	3/4"	2/2 Pilot	1~40 bar	20,00 USD
	1"	2/2 Pilot	1~40 bar	26,00 USD
EMC / PUT / ZS** SERİSİ GENEL MAKSAT SOLENOİD VALF	1/8"	2/2 Pilot & 2/2 Direkt**	0~7 bar	6,00 USD
	1/4"	2/2 Pilot & 2/2 Direkt**	0~7 bar	8,00 USD
	3/8"	2/2 Pilot & 2/2 Direkt**	0~7 bar	11,00 USD
	1/2"	2/2 Pilot & 2/2 Direkt**	0~7 bar	13,00 USD
	3/4"	2/2 Pilot & 2/2 Direkt**	0~10 bar	15,00 USD
	1"	2/2 Pilot & 2/2 Direkt**	0~10 bar	22,00 USD
	1 1/2"	2/2 Pilot & 2/2 Direkt**	0~10 bar	40,00 USD
EMC22 SERİSİ SOLENOİD VALF	1/8"***	2/2 Direkt	0~8 bar	6,00 USD
	1/4"	2/2 Direkt	0~10 bar	8,00 USD
EMC23 SERİSİ SOLENOİD VALF****	1/8"	3/2 Direkt	0~10 bar	8,00 USD
	1/4"	3/2 Direkt	0~10 bar	10,00 USD
SLP SERİSİ 316 PASLANMAZ SOLENOİD VALF	1/8"	2/2 Direkt	0~12 bar	11,00 USD
	1/4"	2/2 Direkt	0~12 bar	12,00 USD
EMCF SERİSİ PATLAÇ VALF	2"		4~6 bar	35,00 USD
HUS SERİSİ PASLANMAZ BUHAR VALFLERİ (250°C)	3/8"	2/2 Direkt	0,5~16 bar	50,00 USD
	1/2"	2/2 Direkt	0,5~16 bar	50,00 USD
	3/4"	2/2 Direkt	0,5~16 bar	55,00 USD
	1"	2/2 Direkt	0,5~16 bar	65,00 USD
EMCP SERİSİ PLASTİK AKT. SS316 GÖVDE PİSTONLU VALF	3/8"	2/2 NK Tek Etkili	0~16 bar	25,00 USD
	1 1/4"	2/2 NK Tek Etkili	0~16 bar	53,00 USD
	1 1/2"	2/2 NK Tek Etkili	0~16 bar	60,00 USD
EMC SERİSİ VALFLER İÇİN BOBİN AC220 / DC24				4,00 USD
SLP SERİSİ VALFLER İÇİN BOBİN AC220				5,00 USD
UD SERİSİ VALFLER İÇİN BOBİN AC220				1,50 USD
ZS SERİSİ VALFLER İÇİN BOBİN AC220 / DC24 (1 1/4" ve üstü için)				10,00 USD
SLG SERİSİ VALFLER İÇİN BOBİN AC220 / DC24				4,00 USD
PU SERİSİ VALFLER İÇİN BOBİN DC24				4,00 USD

*UDH serisi valfler yüksek basınçtır. Çalışma basıncı 0~20 bar
** ZS serisi valfler direkt uyarılıdır

***EMC22 serisi 1/8" ölçüsünde 0~25 bar seçeneği de vardır.
****EMC23 serisinde 0-16 bar seçeneği de vardır.

Fiyatlarımız USD cinsindedir.

FIRSAT ÜRÜNLERİ - NET FİYATLAR

PRINÇ HORTUM KRUVA

Ürün Kodu	NET FİYAT
HORTUM KRUVA SARI 6MM	0,50 USD
HORTUM KRUVA SARI 8MM	0,75 USD
HORTUM KRUVA SARI 10MM	1,00 USD
HORTUM KRUVA SARI 12MM	1,50 USD
HORTUM KRUVA SARI 16MM	2,00 USD



FIRSAT ÜRÜNLERİ - NET FİYATLAR

HİDROPNÖMATİK VE ELEKTRİKLİ SİLİNDİRLER

	Ölçü	NET FİYAT
Hidro-Pnömatik Silindir	PHD-D-63X150-15F	250,00 USD
	PHD-D-80X150-5F	300,00 USD
Servo Motor+Sürücü+Kablo	ELH080H07*1* + ELHS18-E07A	390,00 USD
	ELH080H10*1* + ELHS18-E10A	400,00 USD
	ELH130H15*1* + ELHS18-E15A	470,00 USD
	ELH130H20*1* + ELHS28-E20A	500,00 USD
Elektrikli Silindir+Kaplin	EGE-25-400-SP-KF	720,00 USD
	EGE-25-400-ZR-KF-LN-RB	590,00 USD
	EGE-40-400-SP-KF	1.000,00 USD
	EGE-40-400-ZR-KF-LN-RB	860,00 USD
	ENCE-40-100-1210	FİYAT SORUNUZ



* Açıkta satılır. 2. Sürücü 3. Pnömatik motor 4. Servo motor 5. Motor 6. Aktarıcı motor
7. Elektrikli motor 8. Elektrikli motor 9. Elektrikli motor 10. Elektrikli motor 11. Elektrikli motor

FIRSAT ÜRÜNLERİ - NET FİYATLAR



www.firetech.com.tr

*Ateş AŞ, bu katalogdaki fiyat ve içeriklerde değişiklik yapma hakkına sahiptir.
Baskıdan doğabilecek hatalardan firmamız sorumlu değildir.*

STARLINE

KAAN

FIREFLEX

Adana Merkez / Head Office:
Seyhan Caddesi, No: 17/A,
Ateş İş Hanı, Seyhan / Adana
t: +90 322 352 78 80
f: +90 322 351 92 78

Adana Şube / Branch:
İncirlik Cumhuriyet Mah., İncirlik
Bulvarı, No: 38, Yüreğir / Adana
t: +90 322 346 02 59
f: +90 322 346 02 91

Çerkezköy Şube / Branch:
İsmet Paşa Org. Sanayi Bölgesi,
6. Sokak, No:6, Kapaklı / Tekirdağ
t: 0282 758 38 02
F: 0282 758 38 06

444 30 28

www.firetech.com.tr

info@atesas.com.tr